

**INSTITUTO DE CIENCIAS
DE LA CONSTRUCCIÓN
EDUARDO TORROJA**

C/ Serrano Galvache, 4. 28033 Madrid (Spain)
Tel.: (+34) 91 302 0440 www.ietcc.csic.es
gestiondit@ietcc.csic.es dit.ietcc.csic.es



European Technical Assessment

ETA 14/0467
26/03/2025

English translation prepared by IETcc. Original version in Spanish language

General Part

Technical Assessment Body issuing the European Technical Assessment:
Instituto de Ciencias de la Construcción Eduardo Torroja (IETcc)

Trade name of the construction product

TNUX-n frame anchor

Product family to which the construction product belongs

Plastic anchor of diameters 8 and 10 for use in redundant non-structural systems in concrete and masonry.

Manufacturer

Index - Técnicas Expansivas S.L.
Segador 13
26006 Logroño (La Rioja) Spain.
website: www.indexfix.com

Manufacturing plants

Index plant 2
Index plant 4

This European Technical Assessment contains

36 pages including 3 annexes which form an integral part of this assessment.

This European Technical Assessment is issued in accordance with Regulation (EU) No 305/2011, on the basis of

European Technical Assessment EAD 330284-00-0604 "Plastic anchors for redundant non-structural systems in concrete and masonry", ed. June 2018

This ETA replaces

ETA 14/0467 version 3 issued 20/11/2020



Translations of this European Technical Assessment in other languages shall fully correspond to the original issued document.

Communication of this European Technical Assessment, including transmission by electronic means, shall be in full. However, partial reproduction may be made, with the written consent of the issuing Technical Assessment Body. Any partial reproduction has to be identified as such



SPECIFIC PART

1. Technical description of the product

The frame anchor Index TNUX-n is a plastic anchor in diameters 8 and 10 mm consisting of a plastic sleeve made of polyamide 6 and an accompanying specific screw of electro galvanised, zinc-nickel coated steel or stainless steel.

The plastic plug is expanded by screwing in the specific screw, which presses the sleeve against the wall of the drilled hole. The product is shown in annex A. For the installation process, see information given in annexes C1 and C2.

The performance of the anchor, including installation data, characteristic anchor values and displacements for the design of anchorages, is given in annex C.

The anchor shall only be packaged and supplied as a complete unit.

2. Specification of the intended use in accordance with the applicable European Assessment Document.

2.1 Intended use

This ETA covers fasteners redundant non-structural systems. Redundant non-structural systems mean applications where, if excessive slip or failure of one fastener occurs, it is assumed that the load can be transmitted to adjacent fasteners without violating the requirements on the fixture in the serviceability and ultimate limit state.

The performances given in section 3 are only valid if the anchor is used in compliance with the specifications and conditions given in annex B.

2.2 Relevant general conditions for the use of the product

The assessment methods included or referred to in this EAD have been written based on the manufacturer's request to take into account a working life of the fastener for the intended use of 50 years when installed in the works (provided that the fastener is subject to appropriate installation). These provisions are based upon the current state of the art and the available knowledge and experience.

When assessing the product, the intended use as foreseen by the manufacturer shall be taken into account. The real working life may be, in normal use conditions, considerably longer without major degradation affecting the basic requirements for works.

The indications given as to the working life of the construction product cannot be interpreted as a guarantee neither given by the product manufacturer or its representative nor by EOTA when drafting this EAD nor by the Technical Assessment Body issuing an ETA based on this EAD, but are regarded only as a mean for expressing the expected economically reasonable working life of the product.

This ETA covers fasteners for installation in pre-drilled holes in compacted reinforced or unreinforced normal weight concrete without fibers considering annexes B and C.



3. Performance of the product and references to the methods used for its assessment

The identification tests and the assessment for the intended use of this product according to the Basic Work Requirements (BWR) were carried out in compliance with EAD 330284-00-0604. The characteristics of each system shall correspond to the respective values laid down in following tables of this ETA, checked by IETcc.

Methods of verification and of assessing and judging are listed afterwards.

3.1 Safety in case of fire (BWR 2)

Essential characteristic	Relevant clause in EAD	Performance	Annex
Reaction to fire	2.2.1	Anchorage satisfy requirements for class A1 according to EN 13501	--
Resistance to fire	2.2.2	$F_{Rk,fi,90}$ [kN]	B1

3.2 Mechanical resistance and stability (BWR 4)

Essential characteristic	Relevant clause in EAD	Performance	Annex
Resistance to steel failure under tension loading	2.2.3	$N_{Rk,s}$ [kN]	C1
Resistance to steel failure under shear loading	2.2.4	$V_{Rk,s}$ [kN], $M_{Rk,s}$ [Nm]	C1
Resistance to pull-out or concrete failure under tension loading (base material group a)	2.2.5	$N_{Rk,p}$ [kN]	C3
Resistance in any load direction without lever arm (base material groups b, c, d)	2.2.6	F_{Rk} [kN]	C4 ÷ C27
Edge distance and spacing (base material group a)	2.2.7	c_{cr} , s_{cr} , c_{min} , s_{min} , a , h_{min} [mm]	C1
Edge distance and spacing (base material group b, c, d)	2.2.8	c_{min} , s_{min} , h_{min} [mm]	C4 ÷ C27
Displacements under short-term and long-term loading	2.2.9	δ_0 , δ_∞ [mm]	C3 ÷ C27
Durability: Carbon steel screw Stainless steel screw	2.2.10	Zinc plated screw / zinc nickel screw Stainless steel screw	A2

4. Assessment and Verification of Constancy of Performance (hereinafter AVCP) system applied, with reference to its legal base

The applicable European legal act for the system of Assessment and Verification of Constancy of Performance (see annex V to Regulation (EU) No 305/2011) is 97/463/EC.

The system to be applied is 2+.



5. Technical details necessary for the implementation of the AVCP system, as provided for in the applicable European Assessment Document.

Technical details necessary for the implementation of the AVCP system are laid down in the quality plan which is deposited at IETcc⁽¹⁾.

Prepared by: PhD Julián Rivera (Innovative Products Assessment Unit, IETcc-CSIC)

Issued in Madrid on 26th of March 2025

Mr. Ángel Castillo Talavera
Director

on behalf of Instituto de Ciencias de la Construcción Eduardo Torroja (IETcc – CSIC)

⁽¹⁾ The Quality Plan is a confidential part of the ETA and only handed over to the notified certification body involved in the assessment and verification of constancy of performance.













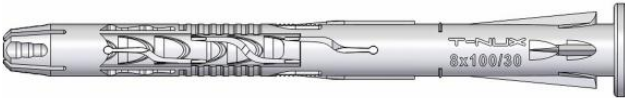

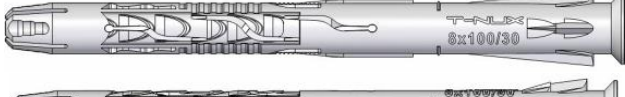
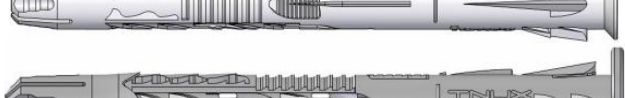
Product	
	Side A
	Side B
	Side A
	Side B
	Side A
	Side B
	Side A
	Side B
<p>Plug marking: type, outer diameter x overall length / thickness to be fixed.</p> <p>Special screw:</p>	
	Hexagonal washer
	Countersunk
	Hexagonal
	Truss
	Threaded
	Pan
TNUX-n anchor	Annex A1
Product description	
Versions	



Table A1: materials

Item	Designation	Material
1	Plastic anchor	Polyamide 6 light grey colour
2	Zinc plated screw	Carbon steel C1022; $f_{uk} = 600 \text{ N/mm}^2$; $f_{yk} = 440 \text{ N/mm}^2$, galvanized $\geq 5 \mu\text{m}$ ISO 4042 Zn5/An/T0nL Zinc-nickel, sealed $\geq 8 \mu\text{m}$ ISO 4042 ZnNi8/Cn/T2nL
3	Stainless steel screw	Stainless steel A2-70 (AISI 304) according to ISO 3506-1 Stainless steel A4-70 (AISI 316) according to ISO 3506-1

Installation condition

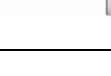
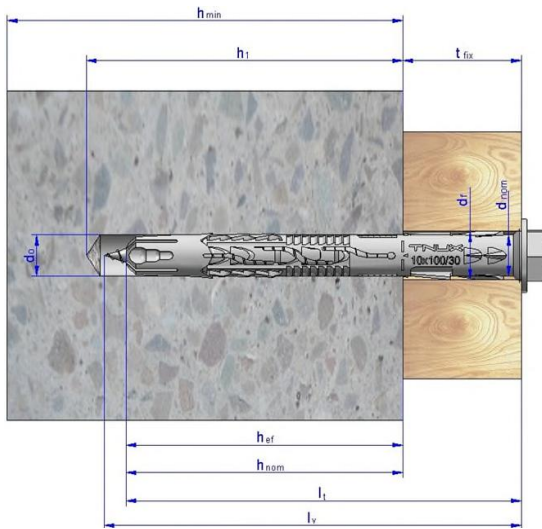

- h_{min} : Minimum thickness of base material
- h_{nom} : Minimum embedment depth
- h_{ef} : Effective embedment depth
- d_{nom} : Outside diameter of anchor:
- l_i : Anchor length
- l_v : Screw length
- d_0 : Drill bit nominal diameter
- h_1 : Minimum hole depth
- t_{fix} : Maximum thickness to be fixed
- d_r : Fixture clearance hole diameter

TNUX-n anchor

Product description

Materials

Annex A2



Specifications of intended use

Anchorage subjected to:

- Non-structural redundant systems (e.g. ventilated façades, cladding stone façades)
- Static or quasi static loads
- According with EAD 330284-00-0604 “2.2.2 Resistance to fire”, it can be assumed that for fastening of façade systems the load bearing behaviour of the Index TNUX-n Ø10 frame anchor has a resistance to fire at least 90 minutes, $F_{Rk,fi,90} = 0,8$ kN (no permanent centric tension load, shear load without lever arm).

Base materials:

Use category	Material
a	<ul style="list-style-type: none"> • Reinforced or unreinforced normal weight concrete • Concrete Strength class C12/15 at minimum and C50/60 at maximum according with EN 206 • Cracked or non-cracked concrete • The anchor TNUX-n 10 may also be used with requirements related to resistance to fire according 3.2
b	<ul style="list-style-type: none"> • Solid masonry walls according to annex C • Mortar strength class \geq M 5 according to EN 998-2
c	<ul style="list-style-type: none"> • Hollow or perforated masonry walls according to annex C • Mortar strength class \geq M 5 according to EN 998-2
d	<ul style="list-style-type: none"> • Prefabricated reinforced autoclaved aerated cracked concrete (AAC2 and AAC6 blocks) according to annex C.

Use conditions (environmental conditions):

- Zinc plated, and A2 stainless steel: Anchorages subjected to dry internal conditions. The specific screw made of galvanized steel and A2 stainless steel may also be used in structures subject to external atmospheric exposure, if the area of head of screw is protected against moisture and driving rain after mounting of the fixing unit in this way, that intrusion of moisture into anchor shaft is prevented. Therefore, there shall be an external cladding or a ventilated rain screen mounted in front of the head of the screw and the head of the screw itself shall be coated with a soft plastic, permanently elastic bitumen-oil-combination coating (e.g. undercoating or body cavity protection for cars)
- A4 stainless steel: The specific screw made of A4 stainless steel may be used in structures subject to dry internal conditions and also in structures subject to external atmospheric exposure (including industrial and marine environment), or exposure in permanently damp internal conditions, if no particular aggressive conditions exist. Such particular aggressive conditions are e.g. permanent, alternating immersion in seawater or the splash zone of seawater, chloride atmosphere of indoor swimming pools or atmosphere with extreme chemical pollution (e.g. in desulphurization plants or road tunnels where de-icing materials are used).
- Exposure to UV due to solar radiation of the anchor not protected \leq 6 weeks
- The plastic anchors are intended to use at temperature bellow 0°C only if water ingress into the hole is avoided.

TNUX-n anchor	Annex B1
Product description	
Specifications	



- Service temperature:

Range	Max. long term temperature	Max. short term temperature
-40 °C to +40 °C	+24 °C	+40 °C
-40 °C to +80 °C	+50 °C	+80 °C

Design:

- The anchorages are designed in accordance with the EOTA TR 064 under the responsibility of an engineer experienced in anchorages and masonry works.
- Verifiable calculation notes and drawings shall be prepared taking account of the loads to be anchored, the nature and strength of the base materials and the dimension of the anchorage members as well as of the relevant tolerances. The position of the anchor is indicated on the design drawings.

Installation:

- Hole drilling by the drill modes according to annex C.
- Anchor installation carried out by appropriately qualified personnel and under the supervision of the person responsible for technical matters of the site.
- Installation temperature ≥ 0 °C

TNUX-n anchor	Annex B2
Product description	
Specifications	



Table C1: Installation parameters

Installation parameters			Performance	
			TNUX-n Ø8	TNUX-n Ø10
d_{nom}	Outside diameter of anchor:	[mm]	8	10
d_0	Nominal diameter of drill bit:	[mm]	8	10
d_f	Fixture clearance hole diameter:	[mm]	8 ÷ 8,5	10 ÷ 11,0
d_f	Fixture clearance hole diameter AAC:	[mm]	8 ÷ 8,2	10 ÷ 10,2
$l_{i,min}$	Minimum anchor length:	[mm]	80	80
$l_{i,max}$	Maximum anchor length:	[mm]	250	300
h_1	Depth of drilled hole:	[mm]	90	90
h_{nom}	Minimum embedment depth:	[mm]	70	70
h_{ef}	Effective anchorage depth:	[mm]	70	70
t_{fix}	Maximum fixture thickness:	[mm]	$l_t - 70$	$l_t - 70$
d_s	Screw diameter:	[mm]	6	7
l_v	Length of screw:	[mm]	$l_t + 6$	$l_t + 6$
l_r	Length of screw thread:	[mm]	80	80
T	Hexalobular socket number (ISO 10664):	[-]	30	40
SW	Wrench size (for hexagonal head only):	[mm]	10	13

Table C2: Screws characteristic resistance

Screws characteristic resistance			Performance			
			TNUX-n Ø8		TNUX-n Ø10	
			Zinc Plated Steel	Stainless steel	Zinc Plated Steel	Stainless steel
$N_{Rk,s}$	Characteristic resistance under tension loading:	[kN]	11,3	13,2	15,3	17,9
γ_{Ms}	Partial safety factor:	[-]	1,64	1,87	1,64	1,87
$V_{Rk,s}$	Characteristic resistance under shear loading:	[kN]	6,5	7,6	9,0	10,5
γ_{fMs}	Partial safety factor:	[-]	1,36	1,55	1,36	1,55
$M_{Rk,s}$	Characteristic bending moment:	[Nm]	10,2	11,9	16,8	19,6
γ_{Ms}	Partial safety factor:	[-]	1,36	1,55	1,36	1,55

It can be assumed that shear loads are acting without a lever arm on an anchor if the following 2 conditions are met:

- The anchor plate is made of metal and in the fixing area. It is fixed directly to the base material without an intermediate layer or with a layer of levelling mortar with a thickness ≤ 3 mm.
- The anchor plate is in contact along its entire thickness with the anchor (therefore the drill bit diameter in the plate d_r must be equal to or less than the value indicated in the table of installation parameters).

If these two conditions are not met simultaneously, the lever arm is calculated according to TR 064. The characteristic bending moment is given in the table above.

TNUX-n anchor

Performance

Installation parameters and screws resistance

Annex C1



Installation process

Installation in concrete and solid bricks

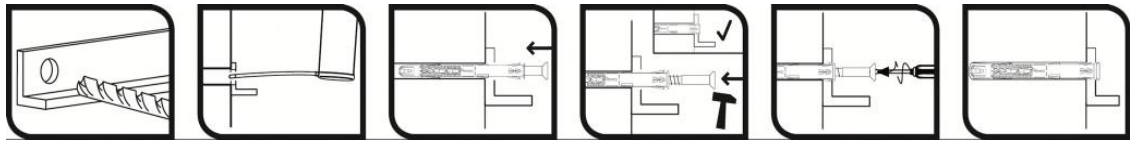

Installation in hollow bricks

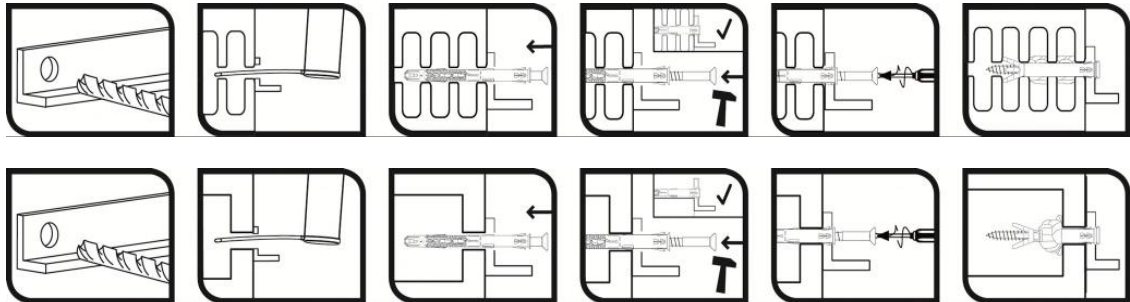

Drawing of edge distance and spacing between anchors in concrete:

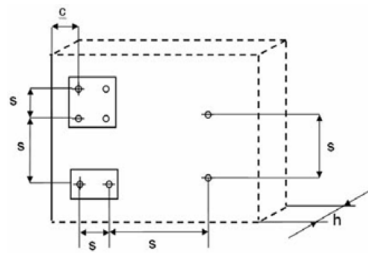

TNUX-n anchor

Performances

Installation procedure

Annex C2



Characteristic resistance in cracked and non-cracked concrete (category of use "a")				Performance			
				TNUX-n Ø8		TNUX-n Ø10	
Resistance to pull out failure							
Range of temperatures				24/40 °C	50/80 °C	24/40 °C	50/80 °C
N _{Rk,p}	Pull-out characteristic resistance:	C12/15	[kN]	2,5	2,5	3,5	3,0
		≥ C16/20	[kN]	3,5	3,5	5,0	4,5
γ _{Mp}	Partial safety factor:		[-]	1.8			
Resistance to concrete failure							
N _{Rk,c}	Resistance in tension: ¹⁾		[kN]	$N_{Rk,c} = 7.2 \sqrt{f_{ck,cubo} \cdot h_{ef}^{1.5} \cdot \frac{c}{c_{cr}}}$ with: $h_{ef}^{1.5} = \frac{N_{Rk,p}}{7.2 \cdot \sqrt{f_{ck,cubo}}}; \frac{c}{c_{cr}} \leq 1$			
V _{Rk,c}	Resistance in shear: ¹⁾		[kN]	$V_{Rk,c} = 0.45 \sqrt{d_{nom}} \left(\frac{h_{nom}}{d_{nom}} \right)^{0.2} \cdot \sqrt{f_{ck,cubo}} \cdot c_1^{1.5} \left(\frac{c_2}{1.5c_1} \right)^{0.5} \left(\frac{h}{1.5c_1} \right)^{0.5}$ with: $\left(\frac{c_2}{1.5c_1} \right)^{0.5} \leq 1; \left(\frac{h}{1.5c_1} \right)^{0.5} \leq 1$ c ₁ : closest distance to edge in the load direction. c ₂ : Edge distance in perpendicular direction to 1. f _{ck,cubo} : Nominal characteristic resistance in concrete compression (based on cube)			
γ _{Mc}	Partial safety factor:		[-]	1.8			
Displacement under tension loads							
N	Service load of concrete in tension:		[kN]	1.19		1.79	
δ _{N0}	Displacements:		[mm]	0.77		0.81	
δ _{N∞}			[mm]	1.54		1.62	
Displacements under shear loads				Carbon steel	Stainless Steel	Carbon steel	Stainless Steel
V	Service load of concrete in shear:		[kN]	1.19		1.79	
δ _{V0}	Displacements:		[mm]	0.70	0.12	0,83	0,34
δ _{V∞}			[mm]	1.05	0.18	1,24	0,51
Minimum concrete thickness, distance between anchors and distance to edge in concrete							
Type of concrete				C12/15	≥ C16/20	C12/15	≥ C16/20
h _{min}	Minimum concrete thickness:		[mm]	100		100	
c _{cr}	Edge distance:		[mm]	140	100	140	100
s _{cr}	Spacing:		[mm]	280	200	280	200
s _{min}	Minimum spacing:		[mm]	85	60	100	70
c _{min}	Minimum edge distance:		[mm]	85	60	100	70
a	Distance between outer anchors of adjoining groups:		[mm]	280	200	280	200
¹⁾ Calculation method according to TR 064							
TNUX-n Anchor						Annex C3	
Performance							
Characteristic values for loading in concrete							



Characteristic resistance in solid masonry (use category "b")		Performance					
		TNUX-n Ø8			TNUX-n Ø10		
Brick no 1: Adoquín 200 x 100 x 50 mm. Ladrillería Técnica.							
Use category	b						
Size:	200 x 100 x 50 mm						
Type:	EN 771-1						
Manufacturer:	Ladrillería Técnica S.A.						
Commercial name:	Adoquín						
Bulk density class ρ :	2060 kg/m ³						
Drill method	Rotary + hammer						
Minimum compressive strength f_b	N/mm ²	30	50	70	30	50	70
Resistance in any load direction without lever arm							
F_{Rk}	Characteristic resistance: [kN]	1,5	2,5	4,0	2,0	3,5	5,0
γ_{Mc}	Partial safety factor: [-]	2,5					
Displacements under tension loads							
N	Service tension load in solid masonry: [kN]	0,43	0,71	1,14	0,57	1,00	1,43
δ_{N0}	Displacements: [mm]	0,76	1,26	2,02	0,42	0,73	1,04
$\delta_{N\infty}$	[mm]	1,52	2,53	4,04	0,84	1,46	2,09
Displacements under shear loads							
V	Service shear load in solid masonry: [kN]	0,43	0,71	1,14	0,57	1,00	1,43
δ_{V0}	Displacements: [mm]	0,22	0,37	0,59	0,22	0,39	0,55
$\delta_{V\infty}$	[mm]	0,33	0,55	0,88	0,33	0,58	0,83
Minimum spacing, edge distance and member thickness							
h_{min}	Minimum thickness of the member: [mm]	100			100		
Single anchor							
s_{min}	Minimum spacing [mm]	250			250		
c_{min}	Minimum edge distance: [mm]	100			100		
Anchor group							
$s_{1,min}$	Spacing perpendicular to free edge: [mm]	200			200		
$s_{2,min}$	Spacing parallel to free edge: [mm]	400			400		
c_{min}	Minimum edge distance: [mm]	100			100		
							
TNUX-n Anchor						Annex C4	
Performance							
Characteristic values for loads in solid masonry							

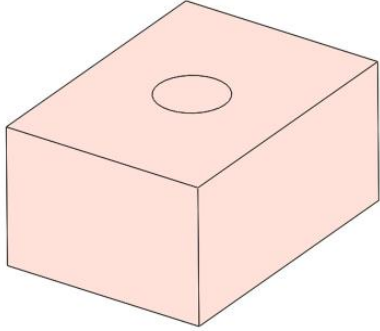
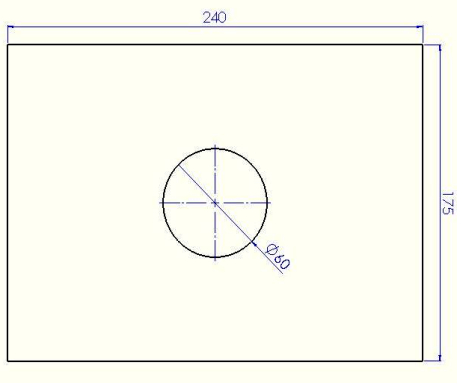

Characteristic resistance in solid masonry (use category "c")		Performance					
		TNUX-n Ø8			TNUX-n Ø10		
Brick no 2: KS12-1.8-3DF, 240 x 175 x 113 mm. Wemding Kalksandstein. Calcium silicate brick KS 12							
Use category	c						
Size:	240 x 175 x 113 mm						
Type:	EN 771-2						
Manufacturer:	Kalksandsteinwerk Wemding GmbH						
Commercial name:	Calcium silicate brick KS 12						
Bulk density class ρ :	1790 kg/m ³						
Drill method	Rotary + hammer						
Minimum compressive strength f_b	N/mm ²	12	20	30	12	20	30
Resistance in any load direction without lever arm							
F_{Rk}	Characteristic resistance: [kN]	3,5	6,0	9,0	3,5	6,0	9,0
γ_{Mc}	Partial safety factor: [-]	2,5					
Displacements under tension loads							
N	Service tension load in hollow masonry: [kN]	1,00	1,71	2,57	1,00	1,71	2,57
δ_{N0}	Displacements: [mm]	0,96	1,65	2,48	0,79	1,35	2,03
$\delta_{N\infty}$	Displacements: [mm]	1,93	3,31	4,96	1,58	2,7	4,06
Displacements under shear loads							
V	Service shear load in hollow masonry: [kN]	1,00	1,71	2,57	1,00	1,71	2,57
δ_{V0}	Displacements: [mm]	0,48	0,82	1,23	0,59	1,01	1,52
$\delta_{V\infty}$	Displacements: [mm]	0,72	1,23	1,85	0,89	1,52	2,28
Minimum spacing, edge distance and member thickness							
h_{min}	Minimum thickness of the member: [mm]	175			175		
Single anchor							
s_{min}	Minimum spacing [mm]	250			250		
c_{min}	Minimum edge distance: [mm]	100			100		
Anchor group							
$s_{1,min}$	Spacing perpendicular to free edge: [mm]	200			200		
$s_{2,min}$	Spacing parallel to free edge: [mm]	400			400		
c_{min}	Minimum edge distance: [mm]	100			100		
							
TNUX-n Anchor						Annex C5	
Performance							
Characteristic values for loads in hollow masonry							

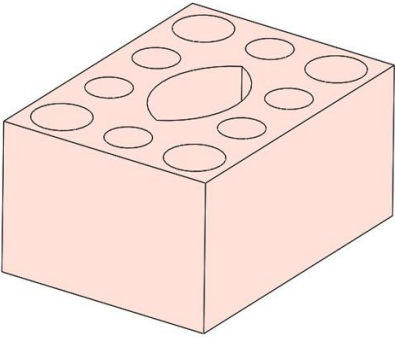
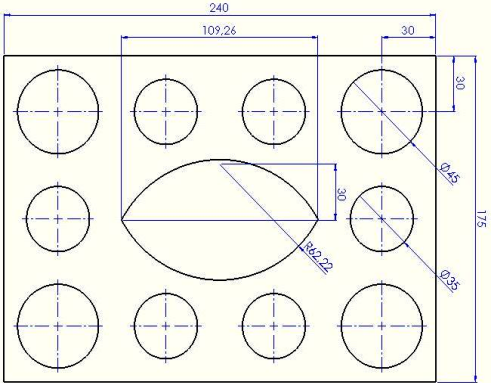

Characteristic resistance in hollow masonry (use category "c").		Performance					
		TNUX-n Ø8			TNUX-n Ø10		
Brick no 3: KS12-1.4-3DF, 240 x 175 x 113 mm. Wemding Kalksandstein. Calcium silicate brick KSL 12							
Use category	c						
Size:	240 x 175 x 113 mm						
Type:	EN 771-2						
Manufacturer:	Kalksandsteinwerk Wemding GmbH						
Commercial name:	Calcium silicate blick KSL 12						
Bulk density class ρ :	1390 kg/m ³						
Drill method:	Rotary + hammer						
Minimum compressive strength f_b :	N/mm ²	12	20	25	12	20	25
Resistance in any load direction without lever arm							
F_{Rk}	Characteristic resistance: [kN]	0,6	1,2	1,5	0,75	1,2	1,5
γ_{Mc}	Partial safety factor: [-]	2.5					
Displacements under tension loads							
N	Service tension load in hollow blocks: [kN]	0,17	0,34	0,43	0,21	0,34	0,43
δ_{N0}	Displacements: [mm]	0,41	0,83	1,03	0,36	0,57	0,71
$\delta_{N\infty}$	Displacements: [mm]	0,83	1,65	2,07	0,71	1,14	1,43
Displacements under shear loads							
V	Service shear load in hollow blocks: [kN]	0,17	0,34	0,43	0,21	0,34	0,43
δ_{V0}	Displacements: [mm]	0,14	0,28	0,35	0,21	0,34	0,42
$\delta_{V\infty}$	Displacements: [mm]	0,21	0,42	0,53	0,32	0,50	0,63
Minimum spacing, edge distance and member thickness							
h_{min}	Minimum thickness of the member: [mm]	113			113		
Single anchor							
s_{min}	Minimum spacing between anchors [mm]	250			250		
c_{min}	Minimum edge distance: [mm]	100			100		
Single anchor							
$s_{1,min}$	Spacing perpendicular to free edge: [mm]	200			200		
$s_{2,min}$	Spacing parallel between anchors to free edge: [mm]	400			400		
c_{min}	Minimum thickness of the member: [mm]	100			100		
							
TNUX-n Anchor					Annex C6		
Performance							
Characteristic values for loads in hollow masonry							

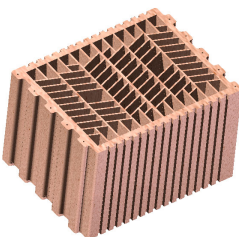
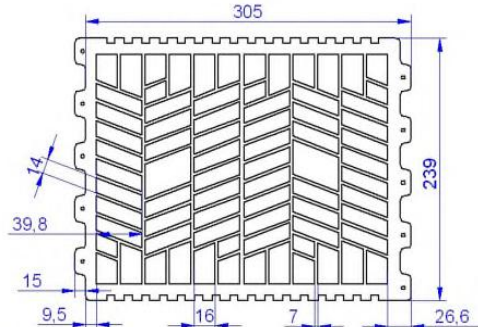

Characteristic resistance in hollow masonry (use category "c").		Performance			
		TNUX-n Ø8		TNUX-n Ø10	
Brick no 4: Termoarcilla de 24: 237 x 305 x 191 mm. Cerabrick					
Use category	c				
Size:	237 x 305 x 191 mm				
Type:	EN 771-1				
Manufacturer:	Cerabrick Grupo Cerámico				
Commercial name:	Termoarcilla de 24				
Bulk density class ρ:	855 kg/m ³				
Drill method:	Rotary				
Minimum compressive strength f _B :	N/mm ²	12,5	15	20	-
Resistance in any load direction without lever arm					
F _{Rk} Characteristic resistance:	[kN]	0,75	0,9	1,2	-
γ _{Mc} Partial safety factor:	[-]	2,5			
Displacements under tension loads					
N Service tension load in hollow masonry:	[kN]	0,21	0,26	0,34	-
δ _{N0} Displacements:	[mm]	0,82	0,98	1,31	-
δ _{N∞} Displacements:	[mm]	1,63	1,96	2,61	-
Displacements under shear loads					
V Service shear load in hollow masonry:	[kN]	0,21	0,26	0,34	-
δ _{V0} Displacements:	[mm]	0,18	0,22	0,29	-
δ _{V∞} Displacements:	[mm]	0,27	0,32	0,43	-
Minimum spacing, edge distance and member thickness					
h _{min} Minimum thickness of the member:	[mm]	237			-
Single anchor					
s _{min} Minimum spacing between anchors	[mm]	250			-
c _{min} Minimum edge distance:	[mm]	100			-
Single anchor					
s _{1,min} Spacing perpendicular to free edge:	[mm]	200			-
s _{2,min} Spacing parallel between anchors to free edge:	[mm]	400			-
c _{min} Minimum edge distance:	[mm]	100			-
					
TNUX-n Anchor					Annex C7
Performance					
Characteristic values for loads in hollow masonry					

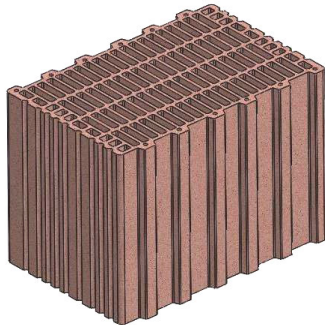
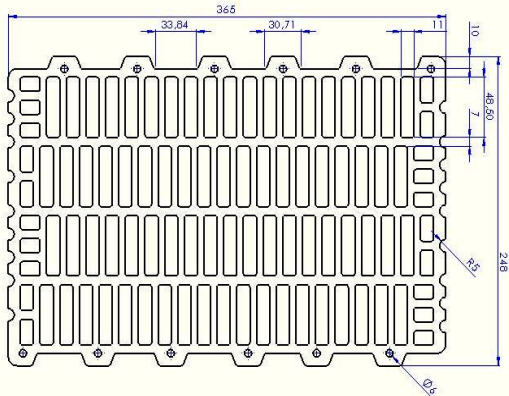

Characteristic resistance in hollow masonry (use category "c").		Performance				
		TNUX-n Ø8		TNUX-n Ø10		
Brick no 5: Planziegel-T16-365, 248 x 365 x 249 mm. Hollow brick POROTON®-T16						
Use category	c					
Size:	248 x 365 x 249 mm					
Type:	EN 771-1					
Manufacturer:	Schlagmann Poroton					
Commercial name:	Planziegel-T16-365					
Bulk density class ρ:	735 kg/m ³					
Drill method:	Rotary					
Minimum compressive strength f _B :	N/mm ²	-	10	12	14	
Resistance in any load direction without lever arm						
F _{Rk}	Characteristic resistance:	[kN]	-	0,6	0,6	0,75
γ _{Mc}	Partial safety factor:	[-]	2,5			
Displacements under tension loads						
N	Service tension load in hollow blocks:	[kN]	-	0,17	0,17	0,21
δ _{N0}	Displacements:	[mm]	-	0,39	0,39	0,49
δ _{N∞}		[mm]	-	0,78	0,78	0,98
Displacements under shear loads						
V	Service shear load in hollow blocks:	[kN]	-	0,17	0,17	0,21
δ _{V0}	Displacements:	[mm]	-	0,12	0,12	0,15
δ _{V∞}		[mm]	-	0,18	0,18	0,23
Minimum spacing, edge distance and member thickness						
h _{min}	Minimum thickness of the member:	[mm]	-	249		
Single anchor						
s _{min}	Minimum spacing	[mm]	-	250		
c _{min}	Minimum edge distance:	[mm]	-	100		
Anchor group						
s _{1,min}	Spacing perpendicular to free edge:	[mm]	-	200		
s _{2,min}	Spacing parallel to free edge:	[mm]	-	400		
c _{min}	Minimum thickness of the member:	[mm]	-	100		
						
TNUX-n Anchor		Annex C8				
Performance						
Characteristic values for loads in hollow masonry						

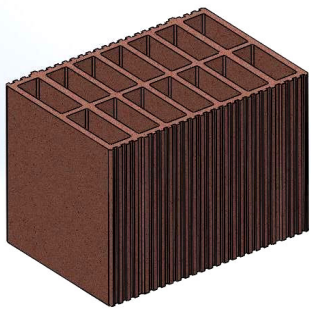
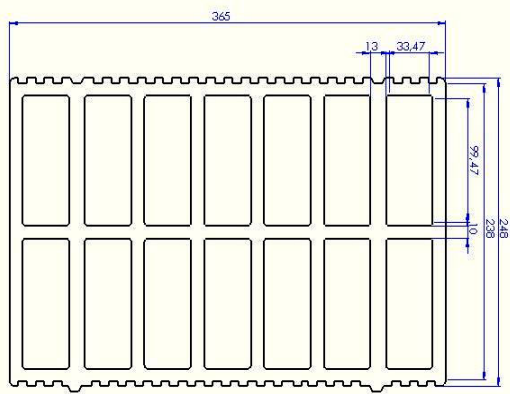

Characteristic resistance in hollow masonry (use category "c").		Performance					
		TNUX-n Ø8			TNUX-n Ø10		
Brick no 6: Poroton S8-365, 248 x 365 x 249 mm. Hollow brick POROTON®-S8							
Use category	c						
Size:	248 x 365 x 249 mm						
Type:	EN 771-1						
Manufacturer:	Schlagmann Poroton						
Commercial name:	Poroton S8-365						
Bulk density class ρ :	720 kg/m ³						
Drill method:	Rotary						
Minimum compressive strength f_b :	10 N/mm ²	10	12	14	10	12	14
Resistance in any load direction without lever arm							
F_{Rk}	Characteristic resistance: [kN]	1,5	2	2	1,5	2	2
γ_{Mc}	Partial safety factor: [-]	2,5					
Displacements under tension loads							
N	Service tension load in hollow blocks: [kN]	0,43	0,57	0,57	0,43	0,57	0,57
δ_{N0}	Displacements: [mm]	0,66	0,88	0,88	0,35	0,47	0,47
$\delta_{N\infty}$	Displacements: [mm]	1,32	1,75	1,75	0,70	0,93	0,93
Displacements under shear loads							
V	Service shear load in hollow blocks: [kN]	0,43	0,57	0,57	0,43	0,57	0,57
δ_{V0}	Displacements: [mm]	0,36	0,48	0,48	0,36	0,48	0,48
$\delta_{V\infty}$	Displacements: [mm]	0,54	0,72	0,72	0,54	0,72	0,72
Minimum spacing, edge distance and member thickness							
h_{min}	Minimum thickness of the member: [mm]	249			249		
Single anchor							
s_{min}	Minimum spacing [mm]	250			250		
c_{min}	Minimum edge distance: [mm]	100			100		
Anchor group							
$s_{1,min}$	Spacing perpendicular to free edge: [mm]	200			200		
$s_{2,min}$	Spacing parallel to free edge: [mm]	400			400		
c_{min}	Minimum thickness of the member: [mm]	100			100		
							
TNUX-n Anchor					Annex C9		
Performance							
Characteristic values for loads in hollow masonry							

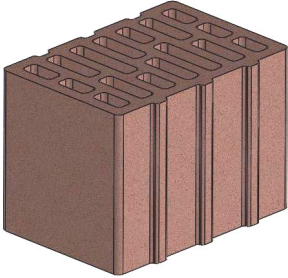
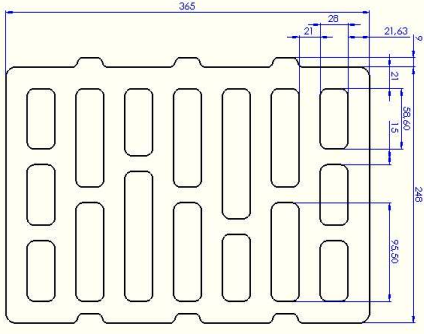

Characteristic resistance in hollow masonry (use category "c").		Performance					
		TNUX-n Ø8			TNUX-n Ø10		
Brick no 7: Poroton-FZ9-365 Objekt, 248 x 365 x 249 mm. Hollow brick POROTON®-FZ9							
Use category	c						
Size:	248 x 365 x 249 mm						
Type:	EN 771-1						
Manufacturer:	Schlagmann Poroton						
Commercial name:	Poroton-FZ9-365 Objekt						
Bulk density class ρ:	830 kg/m ³						
Drill method:	Rotary						
Minimum compressive strength f _B :	10 N/mm ²	10	12	14	10	12	14
Resistance in any load direction without lever arm							
F _{Rk}	Characteristic resistance: [kN]	2,5	3	3,5	2,0	2,5	3
γ _{Mc}	Partial safety factor: [-]	2,5					
Displacements under tension loads							
N	Service tension load in hollow masonry: [kN]	0,71	0,86	1,00	0,57	0,71	0,86
δ _{N0}	Displacements: [mm]	1,19	1,43	1,67	0,42	0,53	0,63
δ _{N∞}	Displacements: [mm]	2,38	2,86	3,33	0,84	1,05	1,26
Displacements under shear loads							
V	Service shear load in hollow masonry: [kN]	0,71	0,86	1,00	0,57	0,71	0,86
δ _{V0}	Displacements: [mm]	0,48	0,58	0,67	0,48	0,60	0,72
δ _{V∞}	Displacements: [mm]	0,72	0,86	1,01	0,72	0,90	1,08
Minimum spacing, edge distance and member thickness							
h _{min}	Minimum thickness of the member: [mm]	249			249		
Single anchor							
s _{min}	Minimum spacing [mm]	250			250		
c _{min}	Minimum edge distance: [mm]	100			100		
Anchor group							
s _{1,min}	Spacing perpendicular to free edge: [mm]	200			200		
s _{2,min}	Spacing parallel to free edge: [mm]	400			400		
c _{min}	Minimum thickness of the member: [mm]	100			100		
							
TNUX-n Anchor						Annex C10	
Performance							
Characteristic values for loads in hollow masonry							

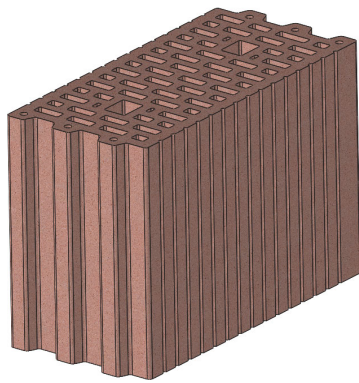
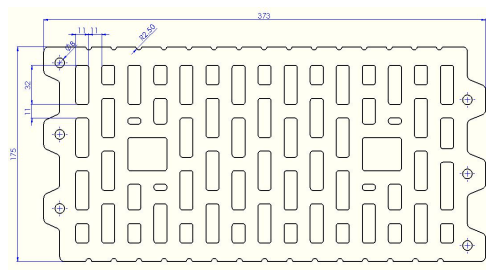

Characteristic resistance in hollow masonry (use category "c").		Performance					
		TNUX-n Ø8			TNUX-n Ø10		
Brick no 8: Schallschutzziegel 373 x 175 x 249 mm. Poroton Clay brick HLz 20							
Use category	c						
Size:	373 x 175 x 249 mm						
Type:	Z-17.1-1090						
Manufacturer:	Wienerberger						
Commercial name:	Schallschutzziegel						
Bulk density class p:	1100 kg/m ³						
Drill method:	Rotary						
Minimum compressive strength f _B :	N/mm ²	20	24	28	20	24	28
Resistance in any load direction without lever arm							
F _{Rk}	Characteristic resistance: [kN]	1,2	1,2	1,5	0,75	0,9	0,9
γ _{Mc}	Partial safety factor: [-]	2,5					
Displacements under tension loads							
N	Service tension load in hollow masonry: [kN]	0,34	0,34	0,43	0,21	0,26	0,26
δ _{N0}	Displacements: [mm]	0,49	0,49	0,61	0,28	0,33	0,33
δ _{N∞}	Displacements: [mm]	0,98	0,98	1,22	0,55	0,67	0,67
Displacements under shear loads							
V	Service shear load in hollow masonry: [kN]	0,34	0,34	0,43	0,21	0,26	0,26
δ _{V0}	Displacements: [mm]	0,22	0,22	0,28	0,14	0,17	0,17
δ _{V∞}	Displacements: [mm]	0,33	0,33	0,41	0,21	0,25	0,25
Minimum spacing, edge distance and member thickness							
h _{min}	Minimum thickness of the member: [mm]	175			175		
Single anchor							
s _{min}	Minimum spacing [mm]	250			250		
c _{min}	Minimum edge distance: [mm]	100			100		
Anchor group							
s _{1,min}	Spacing perpendicular to free edge: [mm]	200			200		
s _{2,min}	Spacing parallel to free edge: [mm]	400			400		
c _{min}	Minimum thickness of the member: [mm]	100			100		
							
TNUX-n Anchor					Annex C11		
Performance							
Characteristic values for loads in hollow masonry							

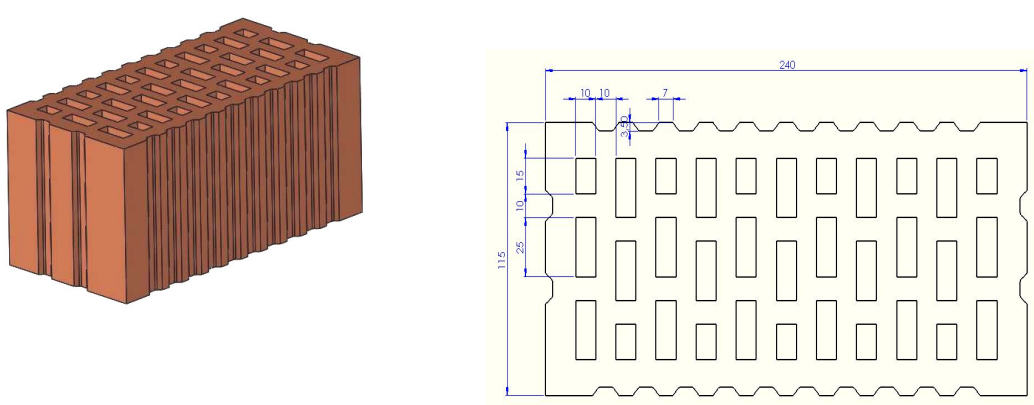

Characteristic resistance in hollow masonry (use category "c").		Performance			
		TNUX-n Ø8		TNUX-n Ø10	
Brick no 9: Poroton-Kleinformat 2DF-0.9 240 x 115 x 113 mm. Poroton Clay brick HLz 12					
Use category	c				
Size:	240 x 115 x 113 mm				
Type:	DIN 105-100				
Manufacturer:	Wienerberger				
Commercial name:	Poroton-Kleinformat 2DF-0.9				
Bulk density class ρ :	855 kg/m ³				
Drill method:	Rotary				
Minimum compressive strength f_b :	N/mm ²	--	12	16	20
Resistance in any load direction without lever arm					
F_{Rk}	Characteristic resistance: [kN]	--	0,4	0,6	0,75
γ_{Mc}	Partial safety factor: [-]	2,5			
Displacements under tension loads					
N	Service tension load in hollow masonry: [kN]	--	0,11	0,17	0,21
δ_{N0}	Displacements: [mm]	--	0,20	0,30	0,37
$\delta_{N\infty}$	Displacements: [mm]	--	0,39	0,59	0,74
Displacements under shear loads					
V	Service shear load in hollow masonry: [kN]	--	0,11	0,17	0,21
δ_{V0}	Displacements: [mm]	--	0,09	0,14	0,17
$\delta_{V\infty}$	Displacements: [mm]	--	0,14	0,20	0,25
Minimum spacing, edge distance and member thickness					
h_{min}	Minimum thickness of the member: [mm]	--	115		
Single anchor					
s_{min}	Minimum spacing [mm]	--	250		
c_{min}	Minimum edge distance: [mm]	--	100		
Anchor group					
$s_{1,min}$	Spacing perpendicular to free edge: [mm]	--	200		
$s_{2,min}$	Spacing parallel to free edge: [mm]	--	400		
c_{min}	Minimum thickness of the member: [mm]	--	100		
					
TNUX-n Anchor				Annex C12	
Performance					
Characteristic values for loads in hollow masonry					

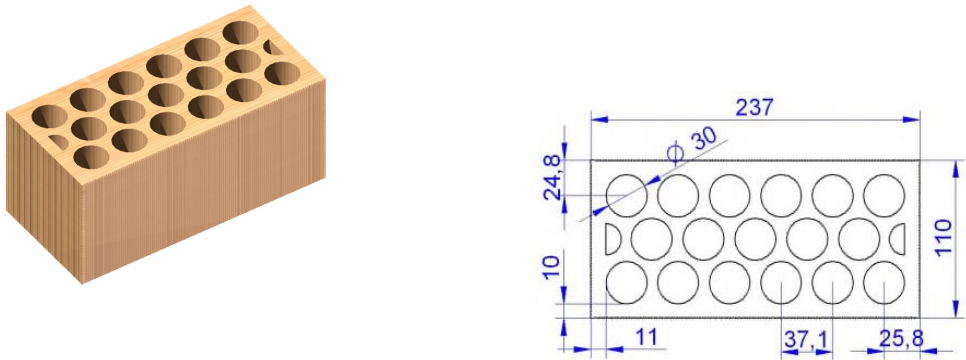

Characteristic resistance in hollow masonry (use category "c").		Performance			
		TNUX-n Ø8		TNUX-n Ø10	
Brick no 10: Cerámica de 10. 237 x 110 x 100 mm. Jumisa					
Use category	c				
Size:	237 x 110 x 100 mm				
Type:	EN 771-1				
Manufacturer:	Juarez y Millas S.A.				
Commercial name:	Cerámica de 10				
Bulk density class ρ :	1025 kg/m ³				
Drill method:	Rotary + hammer				
Minimum compressive strength f_b :	N/mm ²	20	30	40	--
Resistance in any load direction without lever arm					
F_{Rk} Characteristic resistance:	[kN]	0,4	0,6	0,75	--
γ_{Mc} Partial safety factor:	[-]	2,5			
Displacements under tension loads					
N Service tension load in hollow blocks:	[kN]	0,11	0,17	0,21	--
δ_{N0} Displacements:	[mm]	0,48	0,72	0,90	--
$\delta_{N\infty}$	[mm]	0,97	1,45	1,81	--
Displacements under shear loads					
V Service shear load in hollow blocks:	[kN]	0,11	0,17	0,21	--
δ_{V0} Displacements:	[mm]	0,08	0,12	0,15	--
$\delta_{V\infty}$	[mm]	0,12	0,18	0,23	--
Minimum spacing, edge distance and member thickness					
h_{min} Minimum thickness of the member:	[mm]	110		--	
Single anchor					
s_{min} Minimum spacing	[mm]	250		--	
c_{min} Minimum edge distance:	[mm]	100		--	
Anchor group					
$s_{1,min}$ Spacing perpendicular to free edge:	[mm]	200		--	
$s_{2,min}$ Spacing parallel to free edge:	[mm]	400		--	
c_{min} Minimum thickness of the member:	[mm]	100		--	
					
TNUX-n Anchor					Annex C13
Performance					
Characteristic values for loads in hollow masonry					

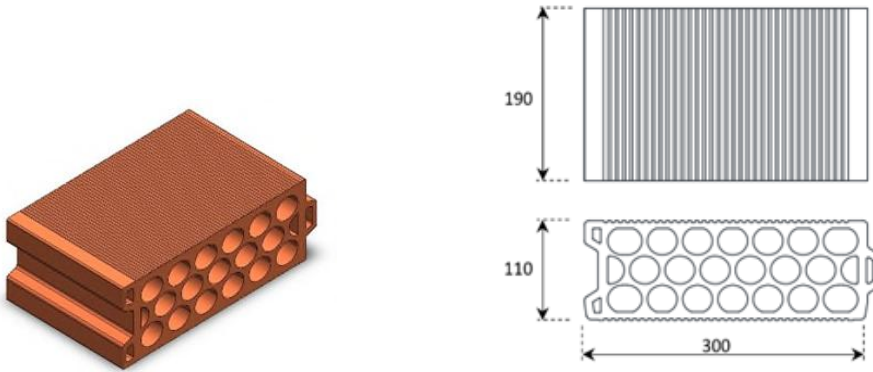

Characteristic resistance in hollow masonry (use category "c")		Performance				
		TNUX-n Ø8		TNUX-n Ø10		
Brick no 11: Hollow brick H20 Cerámica Sampedro						
Use category	c					
Size:	300 x 110 x 190 mm					
Type:	EN 771-1					
Manufacturer:	Cerámica Sampedro					
Commercial name:	H20					
Bulk density class ρ :	815 kg/m ³					
Drill method	Rotary					
Minimum compressive strength f_b	N/mm ²	--	15	25	35	
Resistance in any load direction without lever arm						
F_{Rk}	Characteristic resistance:	[kN]	--	0,5	0,9	1,2
γ_{Mc}	Partial safety factor:	[-]	2,5			
Displacements under tension loads						
N	Service tension load in solid masonry:	[kN]	--	0,14	0,26	0,34
δ_{N0}	Displacements:	[mm]	--	0,28	0,53	0,69
$\delta_{N\infty}$		[mm]	--	0,56	1,06	1,38
Displacements under shear loads						
V	Service shear load in solid masonry:	[kN]	--	0,14	0,26	0,34
δ_{V0}	Displacements:	[mm]	--	0,15	0,28	0,36
$\delta_{V\infty}$		[mm]	--	0,23	0,42	0,54
Minimum spacing, edge distance and member thickness						
h_{min}	Minimum thickness of the member:	[mm]	--	110		
Single anchor						
s_{min}	Minimum spacing	[mm]	--	100		
c_{min}	Minimum edge distance:	[mm]	--	100		
Anchor group						
$s_{1,min}$	Spacing perpendicular to free edge:	[mm]	--	100		
$s_{2,min}$	Spacing parallel to free edge:	[mm]	--	100		
c_{min}	Minimum edge distance:	[mm]	--	100		
						
TNUX-n Anchor					Annex C14	
Performance						
Characteristic values for loads in hollow masonry						

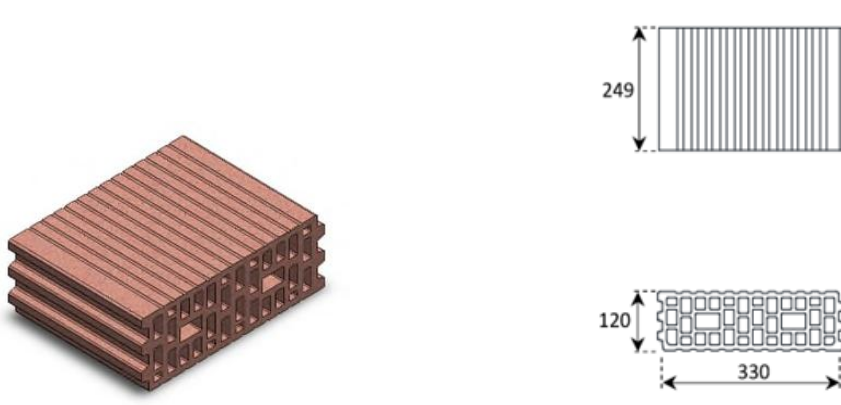

Characteristic resistance in hollow masonry (use category "c")		Performance			
		TNUX-n Ø8		TNUX-n Ø10	
Brick no 12: Hollow brick CITY12 Cerámica Sampedro					
Use category	c				
Size:	330 x 120 x 249 mm				
Type:	EN 771-1				
Manufacturer:	Cerámica Sampedro				
Commercial name:	CITY12				
Bulk density class ρ :	860 kg/m ³				
Drill method	Rotary				
Minimum compressive strength f_b	N/mm ²	--	15	25	35
Resistance in any load direction without lever arm					
F_{Rk}	Characteristic resistance: [kN]	--	0,6	0,9	1,5
γ_{Mc}	Partial safety factor: [-]	2,5			
Displacements under tension loads					
N	Service tension load in solid masonry: [kN]	--	0,17	0,26	0,43
δ_{N0}	Displacements: [mm]	--	0,23	0,35	0,58
$\delta_{N\infty}$	[mm]	--	0,46	0,70	1,16
Displacements under shear loads					
V	Service shear load in solid masonry: [kN]	--	0,17	0,26	0,43
δ_{V0}	Displacements: [mm]	--	0,19	0,29	0,49
$\delta_{V\infty}$	[mm]	--	0,29	0,44	0,74
Minimum spacing, edge distance and member thickness					
h_{min}	Minimum thickness of the member: [mm]	--	120		
Single anchor					
s_{min}	Minimum spacing [mm]	--	100		
c_{min}	Minimum edge distance: [mm]	--	100		
Anchor group					
$s_{1,min}$	Spacing perpendicular to free edge: [mm]	--	100		
$s_{2,min}$	Spacing parallel to free edge: [mm]	--	100		
c_{min}	Minimum edge distance: [mm]	--	100		
					
TNUX-n Anchor				Annex C15	
Performance					
Characteristic values for loads in hollow masonry					

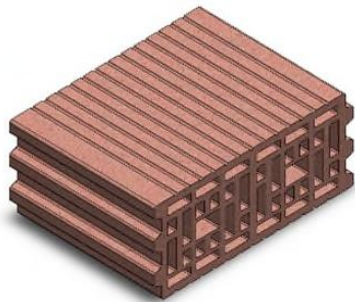
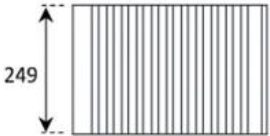
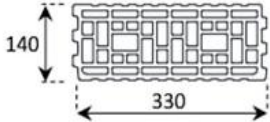

Characteristic resistance in hollow masonry (use category "c")		Performance			
		TNUX-n Ø8		TNUX-n Ø10	
Brick no 13: Hollow brick CITY14 Cerámica Sampedro					
Use category	c				
Size:	330 x 140 x 249 mm				
Type:	EN 771-1				
Manufacturer:	Cerámica Sampedro				
Commercial name:	CITY14				
Bulk density class ρ:	910 kg/m ³				
Drill method	Rotary				
Minimum compressive strength f _b	N/mm ²	--	15	25	35
Resistance in any load direction without lever arm					
F _{Rk}	Characteristic resistance: [kN]	--	0,9	1,5	2,5
γ _{Mc}	Partial safety factor: [-]	2,5			
Displacements under tension loads					
N	Service tension load in solid masonry: [kN]	--	0,26	0,43	0,71
δ _{N0}	Displacements: [mm]	--	0,16	0,27	0,45
δ _{N∞}	[mm]	--	0,32	0,54	0,90
Displacements under shear loads					
V	Service shear load in solid masonry: [kN]	--	0,26	0,43	0,71
δ _{V0}	Displacements: [mm]	--	0,15	0,25	0,42
δ _{V∞}	[mm]	--	0,23	0,38	0,63
Minimum spacing, edge distance and member thickness					
h _{min}	Minimum thickness of the member: [mm]	--	140		
Single anchor					
s _{min}	Minimum spacing [mm]	--	100		
c _{min}	Minimum edge distance: [mm]	--	100		
Anchor group					
s _{1,min}	Spacing perpendicular to free edge: [mm]	--	100		
s _{2,min}	Spacing parallel to free edge: [mm]	--	100		
c _{min}	Minimum edge distance: [mm]	--	100		
					
					
TNUX-n Anchor			Annex C16		
Performance					
Characteristic values for loads in hollow masonry					



Characteristic resistance in hollow masonry (use category "c")		Performance				
		TNUX-n Ø8		TNUX-n Ø10		
Brick no 14: Hollow brick PERFORADO 10 Cerámica Sampedro						
Use category	c					
Size:	245 x 110 x 100 mm					
Type:	EN 771-1					
Manufacturer:	Cerámica Sampedro					
Commercial name:	PERFORADO 10					
Bulk density class ρ :	805 kg/m ³					
Drill method	Rotary					
Minimum compressive strength f_b	N/mm ²	--	15	25	35	
Resistance in any load direction without lever arm						
F_{Rk}	Characteristic resistance:	[kN]	--	0,6	0,9	1,5
γ_{Mc}	Partial safety factor:	[-]	2,5			
Displacements under tension loads						
N	Service tension load in solid masonry:	[kN]	--	0,17	0,26	0,43
δ_{N0}	Displacements:	[mm]	--	0,35	0,53	0,76
$\delta_{N\infty}$		[mm]	--	0,70	1,06	1,52
Displacements under shear loads						
V	Service shear load in solid masonry:	[kN]	--	0,17	0,26	0,43
δ_{V0}	Displacements:	[mm]	--	0,28	0,42	0,70
$\delta_{V\infty}$		[mm]	--	0,42	0,63	1,05
Minimum spacing, edge distance and member thickness						
h_{min}	Minimum thickness of the member:	[mm]	--	110		
Single anchor						
s_{min}	Minimum spacing	[mm]	--	100		
c_{min}	Minimum edge distance:	[mm]	--	100		
Anchor group						
$s_{1,min}$	Spacing perpendicular to free edge:	[mm]	--	100		
$s_{2,min}$	Spacing parallel to free edge:	[mm]	--	100		
c_{min}	Minimum edge distance:	[mm]	--	100		
TNUX-n Anchor					Annex C17	
Performance						
Characteristic values for loads in hollow masonry						

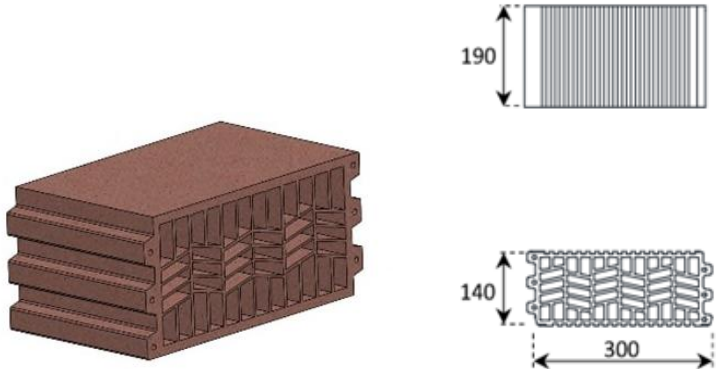

Characteristic resistance in hollow masonry (use category "c")		Performance			
		TNUX-n Ø8		TNUX-n Ø10	
Brick no 15: Hollow brick TERMOARCILLA 14 Cerámica Sampedro					
Use category	c				
Size:	300 x 140 x 190 mm				
Type:	EN 771-1				
Manufacturer:	Cerámica Sampedro				
Commercial name:	TERMOARCILLA 14				
Bulk density class ρ :	855 kg/m ³				
Drill method	Rotary				
Minimum compressive strength f_b	N/mm ²	--	15	25	35
Resistance in any load direction without lever arm					
F_{Rk}	Characteristic resistance: [kN]	--	0,75	1,2	2,0
γ_{Mc}	Partial safety factor: [-]	2,5			
Displacements under tension loads					
N	Service tension load in solid masonry: [kN]	--	0,21	0,34	0,57
δ_{N0}	Displacements: [mm]	--	0,31	0,51	0,66
$\delta_{N\infty}$	[mm]	--	0,62	1,02	1,32
Displacements under shear loads					
V	Service shear load in solid masonry: [kN]	--	0,21	0,34	0,57
δ_{V0}	Displacements: [mm]	--	0,25	0,41	0,61
$\delta_{V\infty}$	[mm]	--	0,38	0,62	0,92
Minimum spacing, edge distance and member thickness					
h_{min}	Minimum thickness of the member: [mm]	--	140		
Single anchor					
s_{min}	Minimum spacing [mm]	--	100		
c_{min}	Minimum edge distance: [mm]	--	100		
Anchor group					
$s_{1,min}$	Spacing perpendicular to free edge: [mm]	--	100		
$s_{2,min}$	Spacing parallel to free edge: [mm]	--	100		
c_{min}	Minimum edge distance: [mm]	--	100		
					
TNUX-n Anchor					Annex C18
Performance					
Characteristic values for loads in hollow masonry					

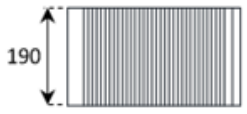
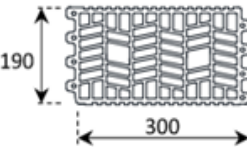

Characteristic resistance in hollow masonry (use category "c")		Performance			
		TNUX-n Ø8		TNUX-n Ø10	
Brick no 16: Hollow brick TERMOARCILLA 19 Cerámica Sampedro					
Use category	c				
Size:	300 x 190 x 190 mm				
Type:	EN 771-1				
Manufacturer:	Cerámica Sampedro				
Commercial name:	TERMOARCILLA 19				
Bulk density class ρ :	790 kg/m ³				
Drill method	Rotary				
Minimum compressive strength f_b	N/mm ²	--	15	25	35
Resistance in any load direction without lever arm					
F_{Rk}	Characteristic resistance: [kN]	--	0,75	1,2	1,5
γ_{Mc}	Partial safety factor: [-]	2,5			
Displacements under tension loads					
N	Service tension load in solid masonry: [kN]	--	0,21	0,34	0,43
δ_{N0}	Displacements: [mm]	--	0,31	0,51	0,64
$\delta_{N\infty}$	[mm]	--	0,62	1,02	1,28
Displacements under shear loads					
V	Service shear load in solid masonry: [kN]	--	0,21	0,34	0,43
δ_{V0}	Displacements: [mm]	--	0,25	0,41	0,51
$\delta_{V\infty}$	[mm]	--	0,38	0,62	0,77
Minimum spacing, edge distance and member thickness					
h_{min}	Minimum thickness of the member: [mm]	--	190		
Single anchor					
s_{min}	Minimum spacing [mm]	--	100		
c_{min}	Minimum edge distance: [mm]	--	100		
Anchor group					
$s_{1,min}$	Spacing perpendicular to free edge: [mm]	--	100		
$s_{2,min}$	Spacing parallel to free edge: [mm]	--	100		
c_{min}	Minimum edge distance: [mm]	--	100		
					
					
TNUX-n Anchor				Annex C19	
Performance					
Characteristic values for loads in hollow masonry					

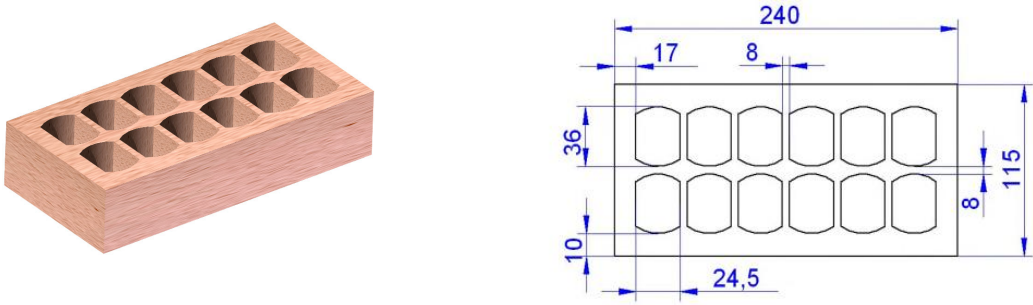

Characteristic resistance in hollow masonry (use category "c").		Performance						
		TNUX-n Ø8			TNUX-n Ø10			
Brick no 17: Ladrillo caravista hidrofugado 240 x 115 x 50 mm. Ladritec								
Use category	c							
Size:	240 x 115 x 50 mm							
Type:	EN 771-1							
Manufacturer:	Ladrillería Técnica S.A							
Commercial name:	Hidrofugado							
Bulk density class ρ:	1065 kg/m ³							
Drill method:	Rotary							
Minimum compressive strength f _b :	N/mm ²	20	30	40	20	30	40	
Resistance in any load direction without lever arm								
F _{Rk}	Characteristic resistance:	[kN]	0,6	0,9	1,2	1,2	1,5	2
γ _{Mc}	Partial safety factor:	[-]	2.5					
Displacements under tension loads								
N	Service tension load in hollow masonry:	[kN]	0,17	0,26	0,34	0,34	0,43	0,57
δ _{N0}	Displacements:	[mm]	0,65	0,97	1,30	0,63	0,79	1,05
δ _{N∞}		[mm]	1,30	1,95	2,60	1,27	1,58	2,11
Displacements under shear loads								
V	Service shear load in hollow masonry:	[kN]	0,17	0,26	0,34	0,34	0,43	0,57
δ _{V0}	Displacements:	[mm]	0,12	0,18	0,24	0,22	0,28	0,37
δ _{V∞}		[mm]	0,18	0,27	0,36	0,33	0,41	0,55
Minimum spacing, edge distance and member thickness								
h _{min}	Minimum thickness of the member:	[mm]	115			115		
Single anchor								
s _{min}	Minimum spacing	[mm]	250			250		
c _{min}	Minimum edge distance:	[mm]	100			100		
Anchor group								
s _{1,min}	Spacing perpendicular to free edge:	[mm]	200			200		
s _{2,min}	Spacing parallel to free edge:	[mm]	400			400		
c _{min}	Minimum edge distance:	[mm]	100			100		
								
TNUX-n Anchor						Annex C20		
Performance								
Characteristic values for loads in hollow masonry								

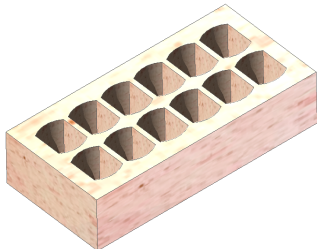
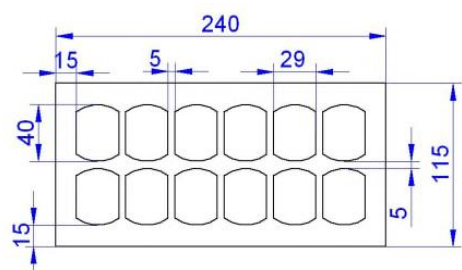

Characteristic resistance in hollow masonry (use category "c").		Performance					
		TNUX-n Ø8			TNUX-n Ø10		
Brick no 18: Clinker Mediterráneo 240 x 115 x 90. Ladrillería Técnica							
Use category	c						
Size:	240 x 115 x 90 mm						
Type:	EN 771-1						
zManufacturer:	Ladrillería Técnica S.A						
Commercial name:	Clinker Mediterráneo						
Bulk density class ρ :	1310 kg/m ³						
Drill method:	Rotary + hammer						
Minimum compressive strength f_b :	N/mm ²	40	50	60	40	50	60
Resistance in any load direction without lever arm							
F_{Rk}	Characteristic resistance: [kN]	0,75	1,2	1,2	1,5	2	2,5
γ_{Mc}	Partial safety factor: [-]	2,5					
Displacements under tension loads							
N	Service tension load in hollow masonry: [kN]	0,21	0,34	0,34	0,43	0,57	0,71
δ_{N0}	Displacements: [mm]	0,44	0,70	0,70	0,65	0,86	1,08
$\delta_{N\infty}$	Displacements: [mm]	0,88	1,40	1,40	1,30	1,73	2,16
Displacements under shear loads							
V	Service shear load in hollow masonry: [kN]	0,21	0,34	0,34	0,43	0,57	0,71
δ_{V0}	Displacements: [mm]	0,18	0,29	0,29	0,36	0,48	0,60
$\delta_{V\infty}$	Displacements: [mm]	0,27	0,43	0,43	0,54	0,72	0,90
Minimum spacing, edge distance and member thickness							
h_{min}	Minimum thickness of the member: [mm]	115			115		
Single anchor							
s_{min}	Minimum spacing [mm]	250			250		
c_{min}	Minimum edge distance: [mm]	100			100		
Anchor group							
$s_{1,min}$	Spacing perpendicular to free edge: [mm]	200			200		
$s_{2,min}$	Spacing parallel to free edge: [mm]	400			400		
c_{min}	Minimum edge distance: [mm]	100			100		
							
TNUX-n Anchor						Annex C21	
Performance							
Characteristic values for loads in hollow masonry							

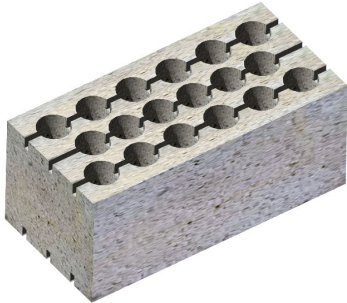
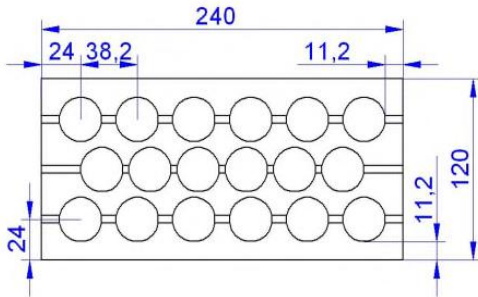

Characteristic resistance in hollow masonry (use category "c").		Performance						
		TNUX-n Ø8			TNUX-n Ø10			
Brick no 19: Bloque gero 240 x 120 x 100 mm. Gilva								
Use category	c							
Size:	240 x 120 x 100 mm							
Type:	EN 771-3							
Manufacturer:	Gilva S.A.							
Commercial name:	Bloque Gero							
Bulk density class ρ:	1180 kg/m ³							
Drill method:	Rotary + hammer							
Minimum compressive strength f _b :	N/mm ²	10	12	14	10	12	14	
Resistance in any load direction without lever arm								
F _{Rk}	Characteristic resistance:	[kN]	0,75	0,9	1,2	1,5	2	2
γ _{Mc}	Partial safety factor:	[-]	2,5					
Displacements under tension loads								
N	Service tension load in hollow masonry:	[kN]	0,21	0,26	0,34	0,43	0,57	0,71
δ _{N0}	Displacements:	[mm]	1,02	1,22	1,63	0,54	0,72	0,90
δ _{N∞}		[mm]	2,04	2,45	3,27	1,08	1,44	1,79
Displacements under shear loads								
V	Service shear load in hollow masonry:	[kN]	0,21	0,26	0,34	0,43	0,57	0,71
δ _{V0}	Displacements:	[mm]	0,18	0,22	0,29	0,36	0,48	0,60
δ _{V∞}		[mm]	0,27	0,32	0,43	0,54	0,72	0,90
Minimum spacing, edge distance and member thickness								
h _{min}	Minimum thickness of the member:	[mm]	120			120		
Single anchor								
s _{min}	Minimum spacing	[mm]	250			250		
c _{min}	Minimum edge distance:	[mm]	100			100		
Anchor group								
s _{1,min}	Spacing perpendicular to free edge:	[mm]	200			200		
s _{2,min}	Spacing parallel to free edge:	[mm]	400			400		
c _{min}	Minimum edge distance:	[mm]	100			100		
								
TNUX-n Anchor						Annex C22		
Performance								
Characteristic values for loads in hollow masonry								

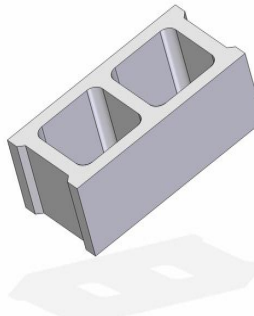
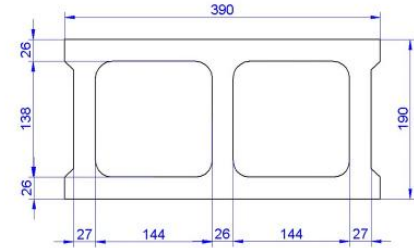

Characteristic resistance in hollow masonry (use category "c").		Performance	
		TNUX-n Ø8	TNUX-n Ø10
Brick no 20: Bloque caravista 390 x 190 x 190 mm. Gallizo			
Use category	c		
Size:	390 x 190 x 190 mm		
Type:	EN 771-3		
Manufacturer:	José María Gallizo S.L.		
Commercial name:	Bloque cara vista		
Bulk density class p:	870 kg/m ³		
Drill method:	Rotary		
Minimum compressive strength f _b :	N/mm ²	5	5
Resistance in any load direction without lever arm			
F _{Rk}	Characteristic resistance: [kN]	1.5	1.5
γ _{Mc}	Partial safety factor: [-]	2.5	
Displacements under tension loads			
N	Service tension load in hollow masonry: [kN]	0,43	0,43
δ _{N0}	Displacements: [mm]	0,51	1,00
δ _{N∞}		1,02	2,00
Displacements under shear loads			
V	Service shear load in hollow masonry: [kN]	0,43	0,43
δ _{V0}	Displacements: [mm]	0,36	0,36
δ _{V∞}		0,54	0,54
Minimum spacing, edge distance and member thickness			
h _{min}	Minimum thickness of the member: [mm]	190	190
Single anchor			
s _{min}	Minimum spacing [mm]	250	250
c _{min}	Minimum edge distance: [mm]	100	100
Anchor group			
s _{1,min}	Spacing perpendicular to free edge: [mm]	200	200
s _{2,min}	Spacing parallel to free edge: [mm]	400	400
c _{min}	Minimum edge distance: [mm]	100	100
			
TNUX-n Anchor			Annex C23
Performance			
Characteristic values for loads in hollow masonry			

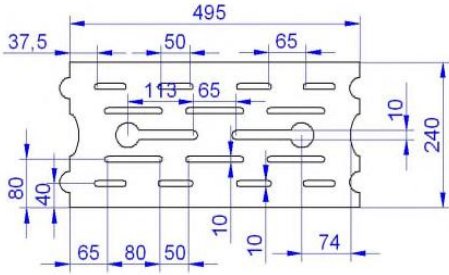

Characteristic resistance in hollow masonry (use category "c").		Performance	
		TNUX-n Ø8	TNUX-n Ø10
Brick no 21: Airblock. 491 x 241 x 190 mm. Viguetas Navarra.			
Use category	c		
Size:	491 x 241 x 190 mm		
Type:	EN 771-3		
Manufacturer:	Viguetas Navarra S.L.		
Commercial name:	Airblock 25		
Bulk density class p:	935 kg/m ³		
Drill method:	Rotary		
Minimum compressive strength f _b :	4 N/mm ²	4	4
Resistance in any load direction without lever arm			
F _{Rk}	Characteristic resistance: [kN]	2,0	1,5
γ _{Mc}	Partial safety factor: [-]	2.5	
Displacements under tension loads			
N	Service tension load in hollow masonry: [kN]	0,57	0,43
δ _{N0}	Displacements: [mm]	0,79	0,65
δ _{N∞}	Displacements: [mm]	1,58	1,30
Displacements under shear loads			
V	Service shear load in hollow masonry: [kN]	0,57	0,43
δ _{V0}	Displacements: [mm]	0,48	0,36
δ _{V∞}	Displacements: [mm]	0,72	0,54
Minimum spacing, edge distance and member thickness			
h _{min}	Minimum thickness of the member: [mm]	241	241
Single anchor			
s _{min}	Minimum spacing [mm]	250	250
c _{min}	Minimum edge distance: [mm]	100	100
Anchor group			
s _{1,min}	Spacing perpendicular to free edge: [mm]	200	200
s _{2,min}	Spacing parallel to free edge: [mm]	400	400
c _{min}	Minimum edge distance: [mm]	100	100
			
TNUX-n Anchor		Annex C24	
Performance			
Characteristic values for loads in hollow masonry			

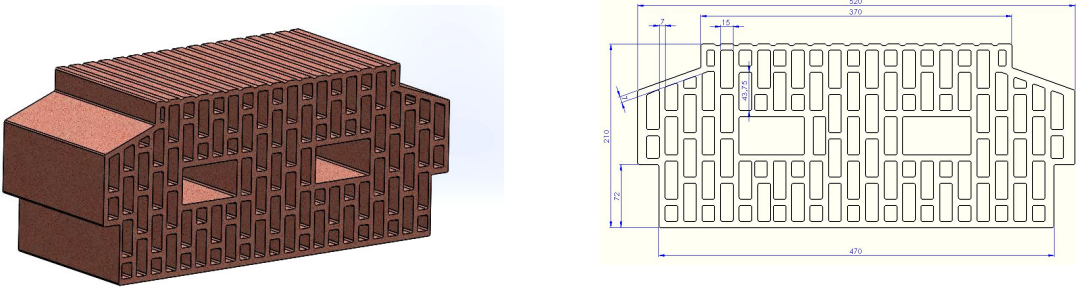

Characteristic resistance in hollow masonry (use category "c").		Performance						
		TNUX-n Ø8			TNUX-n Ø10			
Brick no 22: Wienerberger Deckenelhängezlegel HLz 530 x 210 x 249 mm.								
Use category	c							
Size:	530 x 210 x 249 mm							
Type:	EN 771-1							
Manufacturer:	Weinerberger							
Commercial name:	Poroton Deckenelhängezlegel h21							
Bulk density class ρ:	680 kg/m ³							
Drill method:	Rotary							
Minimum compressive strength f _b :	N/mm ²	12	16	20	12	16	20	
Resistance in any load direction without lever arm								
F _{Rk}	Characteristic resistance:	[kN]	0,3	0,4	0,5	0,6	0,9	1,2
γ _{Mc}	Partial safety factor:	[-]	2,5					
Displacements under tension loads								
N	Service tension load in hollow masonry:	[kN]	0,09	0,11	0,14	0,17	0,26	0,34
δ _{N0}	Displacements:	[mm]	0,42	0,56	0,70	0,41	0,62	0,83
δ _{N∞}		[mm]	0,84	1,11	1,39	0,83	1,24	1,65
Displacements under shear loads								
V	Service shear load in hollow masonry:	[kN]	0,09	0,11	0,14	0,17	0,26	0,34
δ _{V0}	Displacements:	[mm]	0,07	0,09	0,12	0,14	0,21	0,28
δ _{V∞}		[mm]	0,11	0,14	0,18	0,21	0,32	0,42
Minimum spacing, edge distance and member thickness								
h _{min}	Minimum thickness of the member:	[mm]	210			210		
Single anchor								
s _{min}	Minimum spacing	[mm]	250			250		
c _{min}	Minimum edge distance:	[mm]	100			100		
Anchor group								
s _{1,min}	Spacing perpendicular to free edge:	[mm]	200			200		
s _{2,min}	Spacing parallel to free edge:	[mm]	400			400		
c _{min}	Minimum edge distance:	[mm]	100			100		
								
TNUX-n Anchor						Annex C25		
Performance								
Characteristic values for loads in hollow masonry								



Characteristic resistance in hollow reinforced concrete in autoclave: AAC2 / AAC6 Bricks (Use category "d")		Performance				
		TNUX-n Ø8		TNUX-n Ø10		
Range of temperature		24/40°C	50/80°C	24/40°C	50/80°C	
AAC2: 625 x 240 x 250 mm						
Use category:	d					
Sizes:	625 x 240 x 250 mm					
Type:	EN 771-4					
Bulk density class ρ:	360 kg/m ³					
Minimum compressive strength f _B :	2 N/mm ²					
Drill method:	Rotary					
Resistance in any load direction without lever arm						
F _{Rk}	Characteristic resistance:	[kN]	0,4	0,3	0,3	0,3
γ _{Mc}	Partial safety factor:	[-]	2.0			
Displacements under tension loads						
N	Service tension load in hollow reinforced concrete:	[kN]	0.14		0.11	
δ _{N0}	Displacements:	[mm]	0.65		0.43	
δ _{N∞}		[mm]	1.30		0.86	
Displacements under shear loads						
V	Service shear load in hollow reinforced concrete:	[kN]	0.14		0.11	
δ _{V0}	Displacements:	[mm]	0.28		0.22	
δ _{V∞}		[mm]	0.42		0.33	
Minimum spacing, edge distance and member thickness						
h _{min}	Minimum thickness of the member:	[mm]	100		100	
Single anchor						
s _{min}	Minimum spacing	[mm]	250		250	
c _{min}	Minimum edge distance:	[mm]	100		100	
Anchor group						
s _{1,min}	Spacing perpendicular to free edge:	[mm]	200		200	
s _{2,min}	Spacing parallel to free edge:	[mm]	400		400	
c _{min}	Minimum thickness of the member:	[mm]	100		100	
TNUX-n Anchor					Annex C26	
Performance						
Characteristic values for loads in hollow reinforced concrete in autoclave						



Characteristic resistance in hollow reinforced concrete in autoclave: AAC2 / AAC6 Bricks (Use category "d")		Performance				
		TNUX-n Ø8		TNUX-n Ø10		
Range of temperature		24/40°C	50/80°C	24/40°C	50/80°C	
AAC6: 625 x 240 x 250 mm						
Use category:	d					
Sizes:	625 x 240 x 250 mm					
Type:	EN 771-4					
Bulk density class ρ:	710 kg/m ³					
Minimum compressive strength f _B :	6 N/mm ²					
Drill method:	Rotary					
Resistance in any load direction without lever arm						
F _{Rk}	Characteristic resistance:	[kN]	0,9	0,9	1,5	1,2
γ _{Mc}	Partial safety factor:	[-]	2.0			
Displacements under tension loads						
N	Service tension load in hollow reinforced concrete:	[kN]	0.32	0.54		
δ _{N0}	Displacements:	[mm]	1.28	0.78		
δ _{N∞}		[mm]	2.56	1.56		
Displacements under tension loads						
N _{Rk,p}	Service shear load in hollow reinforced concrete:	[kN]	0.32	0.54		
δ _{N0}	Displacements:	[mm]	0.64	1.08		
δ _{N∞}		[mm]	0.96	1,62		
Minimum spacing, edge distance and member thickness						
h _{min}	Minimum thickness of the member:	[mm]	100	100		
Single anchor						
s _{min}	Minimum spacing	[mm]	250	250		
c _{min}	Minimum edge distance:	[mm]	100	100		
Anchor group						
s _{1,min}	Spacing perpendicular to free edge:	[mm]	200	200		
s _{2,min}	Spacing parallel to free edge:	[mm]	400	400		
c _{min}	Minimum thickness of the member:	[mm]	100	100		
TNUX-n Anchor					Annex C27	
Performance						
Characteristic values for loads in hollow reinforced concrete in autoclave						

