

XPE440

Pure Epoxy Injection Mortar

Post-Installed Rebar Technical Data Sheet



Description

XPE440 is an ultimate performance, epoxy injection mortar with approvals for anchoring and rebar connections. This product is used in conjunction with a hand, battery or pneumatic tool and static mixer nozzle.

XPE440 consists of 2 components, resin and hardener, which are stored in separate compartments. These are mixed when extruded through the mixer nozzle and allow the mortar to set. Cartridges may be reused up to end of shelf life by replacing the static mixer nozzle or resealing the cap.

CCPI verified product information: Verification Number 002400004/1027

Usage/Purpose

XPE440 is suitable for anchoring of façades, roofs, wood construction, metal profiles, columns, beams, consoles, railings, sanitary devices, cable trays, piping, post-installed rebar connections and more. Especially suitable for applications with deeper embedment depths due to high flow properties.

Key Benefits

- ETA for cracked and non-cracked concrete, C20/25 to C50/60
- ETA for post-installed rebar connections
- Approved for seismic performance categories C1 and C2
- EN 1992-4 and TR069 design methods supported
- Additional provisions within in the ETA for 100 year working life
- Compatible with hammer or diamond drilled holes
- Very high load capacity in cracked and non-cracked concrete
- Suitable for dry and wet concrete including flooded holes
- Suitable for overhead application
- EPD Declaration number: EPD-VJT-20240220-CBA1-EN
- Fire rating resistance ~ F120
- NSF approval for potable water
- High chemical resistance
- Low odour
- Small allowable edge distance and anchor spacing
- Superior performance in heavy-duty anchoring applications
- Design check can be performed using free VJT DesignFiX software - alternatively contact technical@vjtechnology.com to model applications



Applications

XPE440 injection mortar is used in conjunction with the following:

- Threaded rods eg. VJT Chemical Anchor Studs (zinc, HDG, A2, A4, HCR)
- VJT Internally Threaded Sockets
- Rebar - designed either as anchors (ETAG001/EN1992-4) or post-installed rebars (EN1992-1/TR069)

Certificates

		1343-CPR-M 532-10-CE	1343-CPR-M 532-11-CE	1343-CPR-M 532-12-CE
		ETA-20/0202	ETA-20/0230	ETA-24/0077
		25	25	25
		EAD 330499-01-0601	EAD 33087-00-0601	EAD 332402-00-0601
BWR 1	Mechanical resistance and stability	Option 1 MB - M30 / IT-M6 - IT-M20 / rebar ø8 - ø32 for cracked and non-cracked concrete see DoP Annex C1 to C3	ø8 - ø40 for post-installed rebar connection see DoP Annex C1	ø8 - ø40 for post-installed rebar connection with improved bond splitting behaviour see DoP Annex C1 to C3
BWR 2	Safety in case of fire	-	Class A1 see DoP Annex C2 to C3	NPA
BWR 3	Hygiene, health and the environment	NPA	NPA	NPA



Design anchorage and lap length

The calculation of the design anchoring lengths of reinforcing bars, if used as end anchoring or as overlapping joint, has to consider the details and provisions of the approval ETA-20/0230 and the EN 1992-1-1:2004+AC:2010.

The design load with corresponding failure mode („pull-out failure“ or „steel failure“) were determined for selected rebar diameters and anchorage lengths. The results for end anchoring and overlapping joints are given in the tables below.

The calculations are based on following assumptions:

- Rebar BSt 500 S, $f_{yk} = 500 \text{ N/mm}^2$, Material safety factor of $\gamma_s = 1.15$
- Concrete class C20/25 and „good bond conditions“ acc. EN 1992-1-1:2004+AC:2010 considered. Rebar diameters $\leq d = 40 \text{ mm}$.
- The bond properties of the bars is considered by the coefficients:

α_1	= 1,0;	is for the effect of the form of the bars assuming adequate cover;
		1,0 for straight rebars
α_2	= 1,0;	is for the effect of concrete minimum cover;
		has to be checked
α_3	= 1,0;	is for the effect of confinement by transverse reinforcement;
		1,0 for no transverse reinforcement
α_4	= 1,0;	is for the influence of one or more welded transverse bars;
		1,0 for no welded transverse reinforcement
α_5	= 1,0;	is for the effect of the pressure transverse;
		1,0 if no transverse pressure is assumed
α_6	= 1,5;	is for the percentage of lapped bars relative to the total cross-section area; 1,5 due to the given situation on the construction side

All drilling methods (hammer drilling (HD), compressed air drilling (CD), Hollow drill bit (HDB), Diamond drilling (DD) are considered by the amplification factor of $\alpha_{lb} = 1,0$.

End anchoring of slabs or beams
(e.g. designed as simply supported)

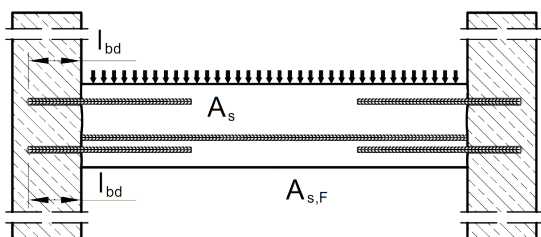

Overlapping joint for rebar connections
of slabs and beams

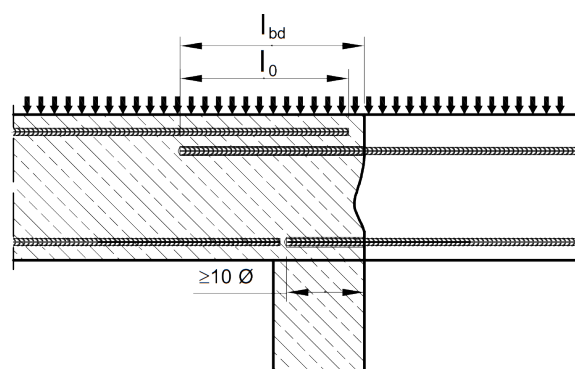

Rebar Ø8 - Ø40			End anchoring			Overlapping joint		
<ul style="list-style-type: none"> Concrete class C20/25 Rebar BSt 500 S; $f_{yk} = 500 \text{ N/mm}^2$ Hammer- (HD), hollow- (HDB) or compressed air (CD) or diamond drilling (DD) 			$\alpha_1 = \alpha_2 = \alpha_3 = \alpha_4 = \alpha_5 = 1,0$			$\alpha_1 = \alpha_2 = \alpha_3 = \alpha_4 = \alpha_5 = 1.0$		
			$\alpha_{lb} = 1.0$			$\alpha_6 = 1.5$		
						$\alpha_{lb} = 1.0$		
d	$N_{Rd,s}$	$l_{v,max}$	l_{bd}	N_{Rd}	Volume Mortar	l_0	N_{Rd}	Volume Mortar ¹⁾
[mm]	[kN]	[mm]	[mm]	[kN]	[ml]	[mm]	[kN]	[ml]
Ø8	21.9	1000	113 ³⁾	6.6	9	200 ⁴⁾	7.7	15
			200	11.6	15	320	12.3	24
			290	16.8	22	440	17.0	33
			378	21.9	29	567	21.9	43
Ø10	34.1	1000	142 ³⁾	10.2	13	213 ⁴⁾	10.2	19
			250	18.1	23	380	18.3	34
			360	26.0	33	550	26.5	50
			473	34.1	43	709	34.1	64
Ø12	49.2	1200 (1000)	170 ³⁾	14.8	18	255 ⁴⁾	14.8	27
			300	26.0	32	450	26.0	48
			430	37.3	45	650	37.6	69
			567	49.2	60	851	49.2	90
Ø14	66.9	1400 (1000)	198 ³⁾	20.1	24	298 ⁴⁾	20.1	36
			350	35.4	42	530	35.7	64
			500	50.6	60	760	51.3	92
			662	66.9	80	992	66.9	120
Ø16	87.4	1600 (1000)	227 ³⁾	26.2	31	340 ⁴⁾	26.2	46
			400	46.2	54	600	46.2	81
			580	67.1	79	860	66.3	117
			756	87.4	103	1134	87.4	154
Ø20	136.6	2000 (1000)	284 ³⁾	41.0	60	425 ⁴⁾	41.0	90
			500	72.3	106	760	73.2	161
			720	104.0	153	1090	105.0	231
			945	136.6	200	1418	136.6	301
Ø22	165.3	2000 (1000)	312 ³⁾	49.6	22	468 ⁴⁾	49.6	132
			550	87.4	39	830	88.0	235
			790	125.6	56	1190	126.1	336
			1040	165.3	73	1560	165.3	441
Ø24	196.7	2000 (1000)	340 ³⁾	59.0	144	510 ⁴⁾	59.0	216
			600	104.0	253	910	105.2	384
			860	149.1	363	1310	151.4	553
			1134	196.7	479	1701	196.7	718
Ø25	213.4	2000 (1000)	354 ³⁾	64.0	133	532 ⁴⁾	64.0	200
			630	113.8	237	950	114.4	357
			910	164.4	342	1360	163.8	511
			1181	213.4	444	1772	213.4	666

¹⁾ Mortar volume of the overlap joint. The mortar volume of the concrete cover c_r , at the face of the existing reinforcing steel, was not taken into account.

²⁾ $l_{v,max}$ See ETA-20/0230. Values in brackets are valid for hollow drill bits only.

³⁾ = $l_{b,min}$ (acc. to EN 1992-1-1:2004)

⁴⁾ = $l_{0,min}$ (acc. to EN 1992-1-1:2004)

Rebar Ø8 - Ø40			End anchoring			Overlapping joint		
<ul style="list-style-type: none"> Concrete class C20/25 Rebar BSt 500 S; $f_{yk} = 500 \text{ N/mm}^2$ Hammer- (HD), hollow- (HDB) or compressed air (CD) or diamond drilling (DD) 			$\alpha_1 = \alpha_2 = \alpha_3 = \alpha_4 = \alpha_5 = 1,0$			$\alpha_1 = \alpha_2 = \alpha_3 = \alpha_4 = \alpha_5 = 1.0$		
			$\alpha_{lb} = 1.0$			$\alpha_6 = 1.5$		
						$\alpha_{lb} = 1.0$		
d	$N_{Rd,s}$	$l_{v,max}$	l_{bd}	N_{Rd}	Volume Mortar	l_0	N_{Rd}	Volume Mortar ¹⁾
[mm]	[kN]	[mm]	[mm]	[kN]	[ml]	[mm]	[kN]	[ml]
Ø28	267.7	2000 (1000)	397 ³⁾	80.3	165	595 ⁴⁾	80.3	247
			710	143.6	295	1060	143.0	441
			1020	206.4	424	1520	205.0	632
			1323	267.7	550	1985	267.7	825
Ø32	349.7	2000 (1000)	454 ³⁾	104.9	246	681 ⁴⁾	104.9	369
			810	187.3	440	1120	172.6	608
			1160	268.2	630	1560	240.5	847
			1512	349.7	821	2000 ²⁾	308.3	1086
Ø34	349.7	2000 (-)	482 ³⁾	118.4	202	723 ⁴⁾	118.4	303
			860	211.3	360	1150	188.3	481
			1230	302.2	515	1580	258.8	661
			1607	394.7	672	2000 ²⁾	327.6	837
Ø36	442.6	2000 (-)	510 ³⁾	127.0	351	766 ⁴⁾	127.0	526
			930	231.4	639	1180	195.7	811
			1350	335.9	928	1590	263.7	1092
			1779	442.6	1222	2000 ²⁾	331.8	1374
Ø40	546.4	2000 (-)	567 ³⁾	149.7	762	851 ⁴⁾	149.7	1142
			1040	274.4	1397	1230	216.4	1652
			1520	401.1	2041	1610	283.2	2162
			2000	527.8	2686	2000 ²⁾	351.9	2686

¹⁾ Mortar volume of the overlap joint. The mortar volume of the concrete cover c_r at the face of the existing reinforcing steel, was not taken into account.

²⁾ $l_{v,max}$ See ETA-20/0230. Values in brackets are valid for hollow drill bits only.

³⁾ $= l_{b,min}$ (acc. to EN 1992-1-1:2004)

⁴⁾ $= l_{0,min}$ (acc. to EN 1992-1-1:2004)

The specified design load N_{Rd} (End anchoring, Overlapping joints) can be converted to further concrete classes, while maintaining the previously accepted boundary conditions and anchorage lengths l_{bd} or lap length l_o , with the approach as follows:

$$N_{Rd,con} = \min(N_{Rd,s}; N_{Rd} * f_{bd,con} - \text{Factor}) \text{ [kN]}$$

The adaptation of the anchorage length l_{bd} or overlap length l_o to different concrete classes can be done for the given design load N_{Rd} from the previous tables using the following equations:

$$l_{bd,con} = \max(l_{b,min}; l_{bd} / f_{bd,con} - \text{Factor}) \text{ [mm]}$$

$$l_{o,con} = \max(l_{o,min}; l_o / f_{bd,con} - \text{Factor}) \text{ [mm]}$$

with:

$l_{bd,con}$ = anchorage length, converted to concrete class [mm]

$l_{o,con}$ = lap length, converted to concrete class [mm]

$l_{bd}; l_{b,min}$ = (minimum) anchorage length acc. to EN 1992-1-1:2004, see previous table [mm]

$l_o; l_{o,min}$ = (minimum) lap length acc. to EN 1992-1-1:2004, see previous table [mm]

The conversion factor $f_{bd,con}$ can be taken from the table below:

Rebar Ø	Ø8 to Ø32 mm ZA-M12 to ZA-M24		Ø 34 mm		Ø 36 mm		Ø 40 mm	
	f_{bd}	$f_{bd,con}$ - Factor	f_{bd}	$f_{bd,con}$ - Factor	f_{bd}	$f_{bd,con}$ - Factor	f_{bd}	$f_{bd,con}$ - Factor
[-]	[N/mm ²]	[-]	[N/mm ²]	[-]	[N/mm ²]	[-]	[N/mm ²]	[-]
C12/15	1.6	0.70	1.6	0.70	1.5	0.68	1.5	0.71
C16/20	2.0	0.87	2.0	0.87	1.9	0.86	1.8	0.86
C20/25	2.3	1.00	2.3	1.00	2.2	1.00	2.1	1.00
C25/30	2.7	1.17	2.6	1.13	2.6	1.18	2.5	1.19
C30/37	3.0	1.30	2.9	1.26	2.9	1.32	2.8	1.33
C35/45	3.4	1.48	3.3	1.43	3.3	1.50	3.1	1.48
C40/50	3.7	1.61	3.6	1.57	3.6	1.64	3.4	1.62
C45/55	4.0	1.74	3.9	1.70	3.8	1.73	3.7	1.76
C50/60	4.3	1.87	4.2	1.83	4.1	1.86	4.0	1.90

Brushes, piston plugs, maximum embedment depth and mixer extension, hammer (HD) and compressed air drilling (CD)

Bar size Ø	Tension anchor Ø	Drill bit-Ø			d _b		d _{b,min} min. Brush Ø	Piston plug	Cartridge: 440 ml or 585 ml				Cartridge: 1400 ml						
		HD	DD	CD	Brush - Ø				Hand or battery tool		Pneumatic tool		Hand or battery tool						
					l _{v,max}	Mixer extension			l _{v,max}	Mixer extension	l _{v,max}	Mixer extension							
[mm]	[mm]	[mm]			[-]	[mm]	[mm]	[-]	[cm]	[-]	[cm]	[-]	[cm]	[-]					
8	-	10			RB10	11,5	10,5	-	250	VL 10/0,75 or VL 16/1,8	250	VL 10/0,75 or VL 16/1,8	250	VL 10/0,75 or VL 16/1,8					
	-	12			RB12	13,5	12,5	-	700		800		800						
10	-	12			RB12	13,5	12,5	-	250		250		250						
	-	14			RB14	15,5	14,5	VS14	700		1000		1000						
12	ZA-M12	14			RB14	15,5	14,5	VS14	250		250		250						
		16			RB16	17,5	16,5	VS16	700		1300		1200						
14	-	18			RB18	20,0	18,5	VS18					700		1300	1400			
16	ZA-M16	20			RB20	22,0	20,5	VS20	500		1000		1600						
20	ZA-M20	25		-	RB25	27,0	25,5	VS25					500		1000	2000			
		-	26	RB26	28,0	26,5	VS25												
22	-	28			RB28	30,0	28,5	VS28		500		1000		2000					
24/25	ZA-M24	32			RB32	34,0	32,5	VS32											
28	-	35			RB35	37,0	35,5	VS35											
32/34	-	40			RB40	43,5	40,5	VS40											
36	-	45			RB45	47,0	45,5	VS45											
40	-	-	52	-	RB52	54,0	52,5	VS52									-	-	-
		55	-	55	RB55	58,0	55,5	VS55									-	-	-

Brushes, piston plugs, maximum embedment depth and mixer extension, hollow drill bit system (HDB)

Bar size Ø	Tension anchor Ø	Drill bit-Ø	d _b		d _{b,min} min. Brush Ø	Piston plug	Cartridge: all sizes				Cartridge: side-by-side (825 ml)	
			Brush - Ø				Hand or battery tool		Pneumatic tool		Hand or battery tool	
		HDB	l _{v,max}	Mixer extension			l _{v,max}	Mixer extension	l _{v,max}	Mixer extension		
[mm]	[mm]	[mm]	[-]	[mm]	[mm]	[-]	[cm]	[-]	[cm]	[-]	[cm]	[-]
8	-	10	No cleaning required	-	250	VL 10/0,75 or VL 16/1,8	250	VL 10/0,75 or VL 16/1,8	250	VL 10/0,75 or VL 16/1,8		
	-	12		-	700		800		800			
10	-	12		-	250		250		250			
	-	14		VS14	700		1000		1000			
12	ZA-M12	14		VS14	250		250		250			
		16		VS16	700		1000		1000			
14	-	18		VS18							700	1000
16	ZA-M16	20		VS20	500		1000		1000			
20	ZA-M20	25		VS25								
22	-	28		VS28								
24/25	ZA-M24	32		VS32								
28	-	35		VS35								
32/34	-	40		VS40								

Cleaning and installation tools

Rec. compressed air tool hand slide valve
(min 6 bar)



Brush RBT and brush extension

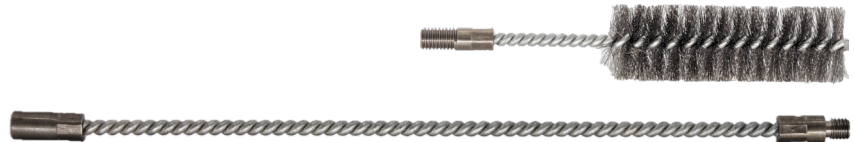

Hand pump (volume 750 ml)



SDS Plus Adapter



HDB - Hollow drill bit



Working and Curing Time

Concrete temperature	Gelling working time	Minimum curing time in dry concrete	Minimum curing time in wet concrete
0°C to +4°C	80 mins	122 hours	244 hours
+5°C to +9°C	80 mins	48 hours	96 hours
+10°C to +14°C	60 mins	28 hours	56 hours
+15°C to +19°C	40 mins	18 hours	36 hours
+20°C to +24°C	30 mins	12 hours	24 hours
+25°C to +34°C	12 mins	9 hours	18 hours
+35°C to +39°C	8 mins	6 hours	12 hours
+40°C	8 mins	4 hours	8 hours
Cartridge temperature	+5°C to +40°C		

Installation instruction

A) Bore hole drilling	
<p>Note: Before drilling, remove carbonated concrete and clean contact areas. In case of aborted drill hole: the drill hole shall be filled with mortar.</p>	
	<p>1a. Hammer (HD) or compressed air drilling (CD). Drill a hole into the base material to the size and embedment depth required by the selected reinforcing bar. Proceed with Step B1.</p>
	<p>1b. Hollow drill bit system (HDB). Drill a hole into the base material to the size and embedment depth required by the selected reinforcing bar. This drill system removes the dust and cleans the bore hole during drilling. Proceed with Step C.</p>
	<p>1c. Diamond drilling (DD). Drill with diamond drill a hole into the base material to the size and embedment depth required by the selected anchor. Proceed with Step B2.</p>
<p>Attention! Standing water in the bore hole must be removed before cleaning.</p>	
B1) Bore hole cleaning	
<p>CAC: Cleaning for all bore hole diameter and bore hole depth with drilling method HD and CD</p>	
	<p>2a. Starting from the bottom or back of the bore hole, blow the hole clean with compressed air (min. 6 bar) (see page 8) a minimum of two times until return air stream is free of noticeable dust. If the bore hole ground is not reached an extension shall be used.</p>
	<p>2b. Check the brush diameter (see page 7). Brush the hole with an appropriate sized wire brush $> d_{b,min}$ (see page 7) a minimum of two times. If the borehole ground is not reached with the brush, a brush extension shall be used.</p>
	<p>2c. Finally blow the hole clean again with compressed air (min. 6 bar) (see page 8) a minimum of two times until return air stream is free of noticeable dust. If the bore hole ground is not reached an extension shall be used.</p>
<p>After cleaning, the bore hole has to be protected against re-contamination in an appropriate way, until dispensing the mortar in the bore hole. If necessary, the cleaning has to be repeated directly before dispensing the mortar. In-flowing water must not contaminate the bore hole again.</p>	

B2) Bore hole cleaning

SPCAC: Cleaning for all bore hole diameter and bore hole depth with drilling method DD

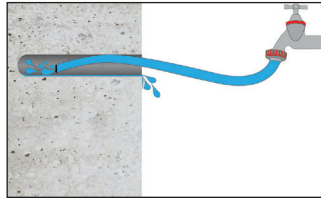

2a. Rinsing with water until clear water comes out.

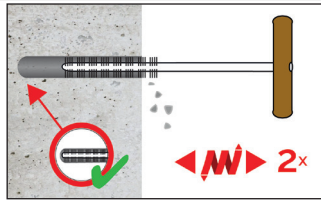

2b. Check the brush diameter (see page 7). Brush the hole with an appropriate sized wire brush $> d_{b,min}$ (see page 7) a minimum of two times.
If the borehole ground is not reached with the brush, a brush extension shall be used.

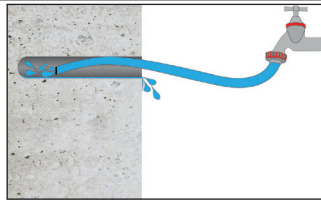

2c. Rinsing again with water until clear water comes out.

Attention! Standing water in the bore hole must be removed before cleaning.

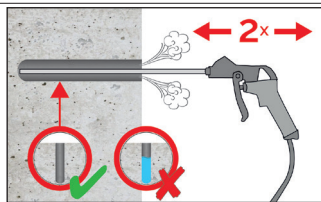

2a. Starting from the bottom or back of the bore hole, blow the hole clean with compressed air (min. 6 bar) (see page 8) a minimum of two times until return air stream is free of noticeable dust.
If the bore hole ground is not reached an extension shall be used

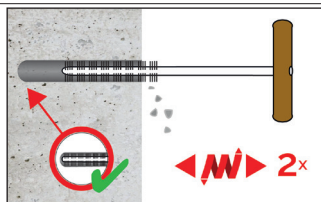

2b. Check the brush diameter (see page 7). Brush the hole with an appropriate sized wire brush $> d_{b,min}$ (see page 7) a minimum of two times.
If the borehole ground is not reached with the brush, a brush extension shall be used.

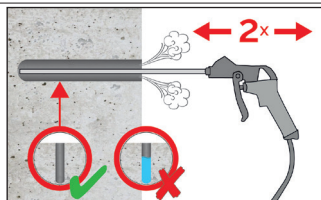

2c. Finally blow the hole clean again with compressed air (min. 6 bar) (see page 8) a minimum of two times until return air stream is free of noticeable dust. If the bore hole ground is not reached an extension shall be used.

After cleaning, the bore hole has to be protected against re-contamination in an appropriate way, until dispensing the mortar in the bore hole. If necessary, the cleaning has to be repeated directly before dispensing the mortar. In-flowing water must not contaminate the bore hole again.

C) Preparation of bar and cartridge

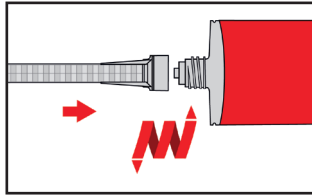

3a. Attach the static mixer tightly onto the cartridge and insert the cartridge into a suitable dispensing tool. For every working interruption longer than the recommended working time (see page 8) as well as for new cartridges, a new static-mixer shall be used.

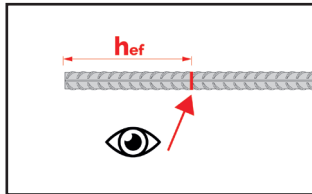

3b. Prior to inserting the reinforcing bar into the filled bore hole, the position of the embedment depth shall be marked (e.g. with tape) on the reinforcing bar and insert bar in empty hole to verify hole and depth l_v (see page 3). The bar should be free of dirt, grease, oil or other foreign material.

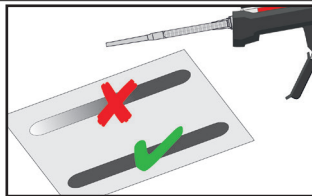

3c. Prior to dispensing into the anchor hole, squeeze out separately the mortar until it shows a consistent grey colour, but a minimum of three full strokes and discard non-uniformly mixed adhesive components.

D) Filling the bore hole

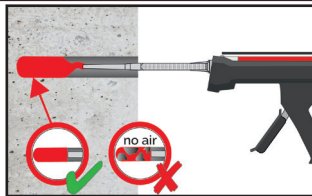

4. Starting from the bottom or back of the cleaned bore hole with adhesive, until the level mark at the mixer extension (see below) is visible at the top of the hole. Slowly withdraw the static mixing nozzle and using a piston plugs during injection of the mortar, helps to avoid creating air pockets.

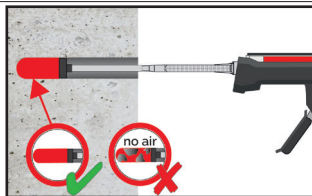

For overhead and horizontal installation and bore holes deeper than 240 mm a piston plug and the appropriate mixer extension must be used. Observe the gel-/working times given on table page 8.

E) Inserting the rebar	
	<p>5a. Push the reinforcing bar into the anchor hole while turning slightly to ensure positive distribution of the adhesive until the embedment depth is reached.</p> <p>The bar should be free of dirt, grease, oil or other foreign material.</p>
	<p>5b. Be sure that the bar is inserted in the bore hole until the embedment mark is at the concrete surface and that excess mortar is visible at the top of the hole. If these requirements are not maintained, the application has to be renewed. For overhead application the anchor rod shall be fixed (e.g. wedges).</p>
	<p>5c. Observe gelling time t_{gel}. Attend that the gelling time can vary according to the base material temperature (see page 8). It is not allowed to move the bar after gelling time t_{gel} has elapsed. Allow the adhesive to cure to the specified time prior to applying any load. Do not move or load the bar until it is fully cured (attend table on page 8). After full curing time t_{cure} has elapsed, the add-on part can be installed.</p>

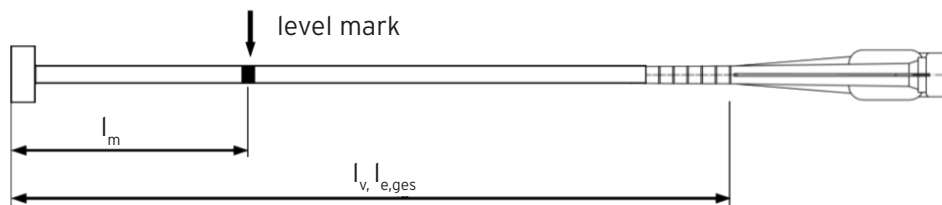

Injection tool must be marked by mortar level mark l_m and anchorage depth l_v resp. $l_{e, ges}$ with tape or marker.

Quick estimation: $l_m = 1/3 * l_v$

Continue injection until mortar level mark l_m becomes visible.

Optimum mortar volume: $l_m = l_v \text{ rep. } l_{e, ges} * (1,2 * \frac{\varnothing^2}{d_0^2} * 0,2)$ [mm]

Fire resistance - Overlapping joints

The present tables are supplying the mean reduction factor $\bar{k}_{\Theta(x)}$, needed for determining the design bond strength $f_{bd,fi}$ of post-installed rebar connections under fire exposure in a fire-resistance grating.

The specified mean reduction factor $\bar{k}_{\Theta(x)}$ is valid for slab to slab connections (overlapping joints), where the lower surface is exposed perpendicular to fire (one side), the temperature is uniform. Therefore the bond resistance is uniform along the bond also and depends on the concrete cover and the duration of the fire.

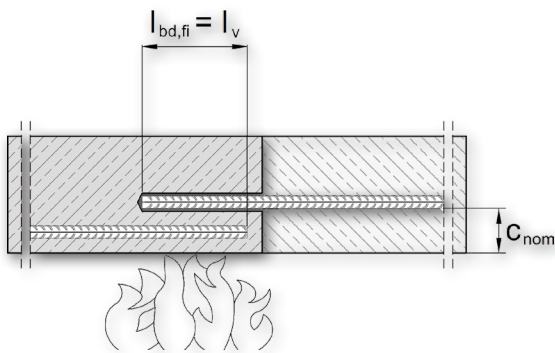

The heat development of structural members is calculated by a fire model, based on the standard uniform-temperature-time-curve (UTTC) acc. to ISO 834-1 and tries to simulate a real fire. Below the calculated heat distribution of a slab after a temperature impact of 14400 sec. (240min) for the fire-resistance grade R240.

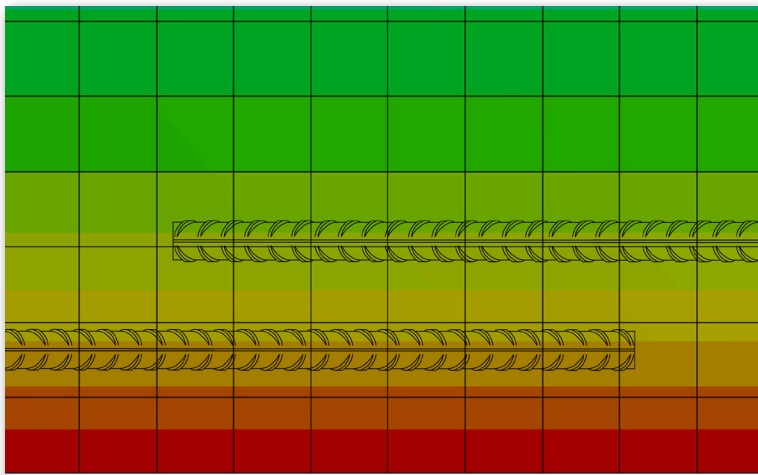

The effect of heat on the bond strength of the mortar was determined by tests and is expressed by the reduction factor $k_{b,fi}(\Theta)$ given in the ETA-20/0230.

The calculation of the required design lap length l_0 shall be carried out in accordance with EN 1992-1-1:2004+AC:2010, section 8.7.3 and the provisions of the ETA-20/0230 and or UKTA-22/6261 shall be met. The design value of the bond strength $f_{bd,fi}$ under fire exposure has to be calculated by the following equation:

$$f_{bd,fi} = \bar{k}_{\Theta(x)} * f_{bd,PIR} * \gamma_c / \gamma_{M,fi} * f_{bd,fi,con} \leq f_{bd,PIR}$$

with:

$f_{bd,fi}$ = Design value of the bond strength under fire exposure in N/mm²

$\bar{k}_{\Theta(x)}$ = Mean reduction factor under fire exposure as a function of the temperature profile, given in the tables below

$f_{bd,PIR}$ = Design value of the bond strength in cold condition acc. ETA-20/0230, tab. C2 depending on concrete class, rebar diameter, drilling method and bonding range acc. EN 1992-1-1 in N/mm²

γ_c = Partial safety factor of concrete acc. EN 1992-1-1;
1,5 in absence of national regulation

$\gamma_{M,fi}$ = Partial safety factor of fire exposure acc. EN 1992-1-2;
1,0 in absence of national regulation

$f_{bd,fi,con}$ = Conversion factor taking into account the influence of the concrete class

The mean reduction factor $\bar{k}_{\Theta(x)}$ for slab to slab connections with rebar Ø8 - Ø40 mm and fire at 30, 60, 90, 120, 180 or 240 min is given for a concrete cover c_{nom} in the present table and valid for good bond conditions only.

Overlapping joint						
Rebar Ø8 - Ø40mm	Mean reduction factor under fire exposure $\bar{k}_{\Theta(x)}$ ²⁾					
	Fire-resistance grading					
c_{nom} ¹⁾	R30	R60	R90	R120	R180	R240
[mm]	[-]	[-]	[-]	[-]	[-]	[-]
10	0,00	0,00	0,00	0,00	0,00	0,00
15						
20						
25						
30	0,07	0,07	0,06	0,06	0,00	0,00
35	0,09					
40	0,12					
45	0,16					
50	0,21	0,07	0,07	0,07	0,00	0,00
55	0,28	0,08				
60	0,36	0,10				
65	0,47	0,13				
70	0,58	0,15	0,08	0,06	0,00	0,00
75	0,72	0,18	0,10			
80	0,86	0,22	0,11			
85	1,00	0,26	0,13			
90	1,00	0,31	0,15	0,10	0,10	0,10

Overlapping joint						
Rebar Ø8 - Ø40mm	Mean reduction factor under fire exposure $\bar{k}_{\theta(x)}$ ²⁾					
	Fire-resistance grading					
c_{nom} ¹⁾	R30	R60	R90	R120	R180	R240
[mm]	[-]	[-]	[-]	[-]	[-]	[-]
95	1,00	0,36	0,17	0,11	0,06	0,00
100	1,00	0,42	0,20	0,13	0,07	
105	1,00	0,49	0,23	0,14	0,08	
110	1,00	0,57	0,27	0,16	0,09	0,06
115	1,00	0,65	0,31	0,18	0,10	0,07
120	1,00	0,76	0,35	0,21	0,11	0,07
125	1,00	0,86	0,40	0,24	0,12	0,08
130	1,00	0,97	0,46	0,27	0,14	0,09
135	1,00	1,00	0,52	0,31	0,15	0,10
140	1,00	1,00	0,58	0,34	0,17	0,11
145	1,00	1,00	0,66	0,39	0,19	0,12
150	1,00	1,00	0,74	0,44	0,21	0,13
155	1,00	1,00	0,83	0,49	0,23	0,14
160	1,00	1,00	0,94	0,54	0,26	0,16
165	1,00	1,00	1,00	0,61	0,29	0,17
170	1,00	1,00	1,00	0,68	0,32	0,19
175	1,00	1,00	1,00	0,74	0,35	0,21
180	1,00	1,00	1,00	0,81	0,38	0,23

¹⁾ c_{nom} = concrete cover

²⁾ $\bar{k}_{\theta(x)}$ = Mean reduction factor over the embedment depth of the rebar as a function of the temperature profile.

Intermediate values of $\bar{k}_{\theta(x)}$ may be interpolated linearly. Extrapolation is not permitted.

The bond strength $f_{bd,PIR}$ depends on the concrete class and rebar diameter as well as the corresponding conversion factor $f_{bd,fi,con}$ and can be found in the following table:

Concrete class	Ø-Rebar	$f_{bd,PIR}$ (all drilling methods)	$f_{bd,fi,con}$ - Factor
[-]	[mm]	[N/mm ²]	[-]
C12/15	Ø8 - Ø34	1,6	1,44
	Ø36, Ø40	1,5	1,53
C16/20	Ø8 - Ø34	2,0	1,15
	Ø36	1,9	1,21
	Ø40	1,8	1,28
C20/25	Ø8 - Ø34	2,3	1,00
	Ø36	2,2	1,05
	Ø40	2,1	1,10
C25/30	Ø8 - Ø32	2,7	0,85
	Ø34, Ø36	2,6	0,88
	Ø40	2,5	0,92
C30/37	Ø8 - Ø32	3,0	0,77
	Ø34, Ø36	2,9	0,79
	Ø40	2,8	0,82
C35/45	Ø8 - Ø32	3,4	0,68
	Ø34, Ø36	3,3	0,70
	Ø40	3,1	0,74
C40/50	Ø8 - Ø32	3,7	0,62
	Ø34, Ø36	3,6	0,64
	Ø40	3,4	0,68
C45/55	Ø8 - Ø32	4,0	0,58
	Ø34	3,9	0,59
	Ø36	3,8	0,61
	Ø40	3,7	0,62
C50/60	Ø8 - Ø32	4,3	0,53
	Ø34	4,2	0,55
	Ø36	4,1	0,56
	Ø40	4,0	0,58

The given values does not deal with the mechanical design at ambient temperature, these shall be done in addition and related to ETA-20/0230.

Post-installed rebar connections shall be designed in ambient temperature conditions before being designed in fire conditions.

The partial safety factor for actions can be assumed to be $\gamma_F = 1,0$ for determining recommended loads.

Fire resistance - Beam/wall or column/slab

The present table is supplying the mean reduction factor $\bar{k}_{\Theta(x)}$, needed for determining the design bond strength $f_{bd,fi}$ of post-installed rebar connections under fire exposure in a fire-resistance rating. The mean reduction factor $\bar{k}_{\Theta(x)}$ is valid for beam to wall or column to slab connections, where the rebar is bonded inside the wall or slab, there is a temperature gradient in the thickness of the wall respectively slab if the beam (three sides) or column is exposed to fire (four sides).

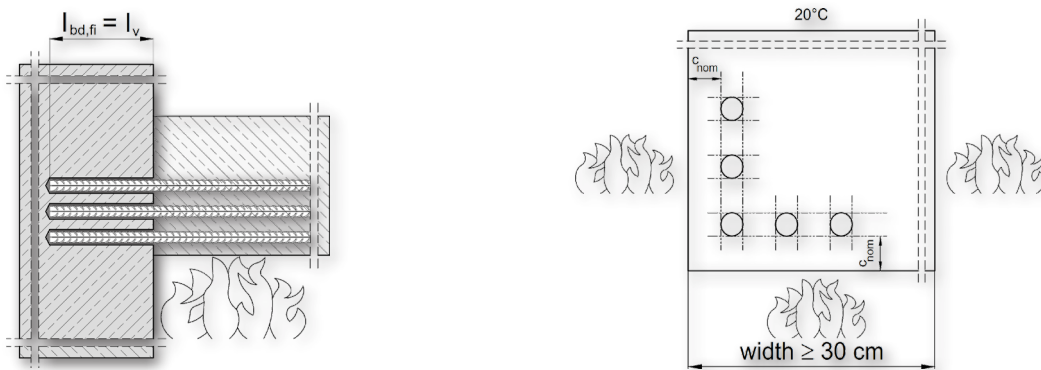

The temperature along the bonding interface is not uniform and depends on the fire duration, the anchoring length and the concrete cover of the rebar inside the beam (which acts as a protection against thermal exposure). Therefore, the temperature profiles along the bond are determined for each fire duration, for each bonded length and for the concrete covers inside the beam of $c_{nom} = 10, 20, 30$ and 40 mm.

The given mean reduction factor $\bar{k}_{\Theta(x)}$ is a mean value as a function of the temperature profile along the bonding length.

The calculated model of the fire is based on the standard uniform-temperature-time-curve (UTTC) acc. to ISO 834-1 and tries to simulate the heat development of structural members at a real fire. Below the calculated heat distribution of a beam / column and wall / slab after a temperature impact of 14400 sec. (240min) for the fire-resistance grade R240.

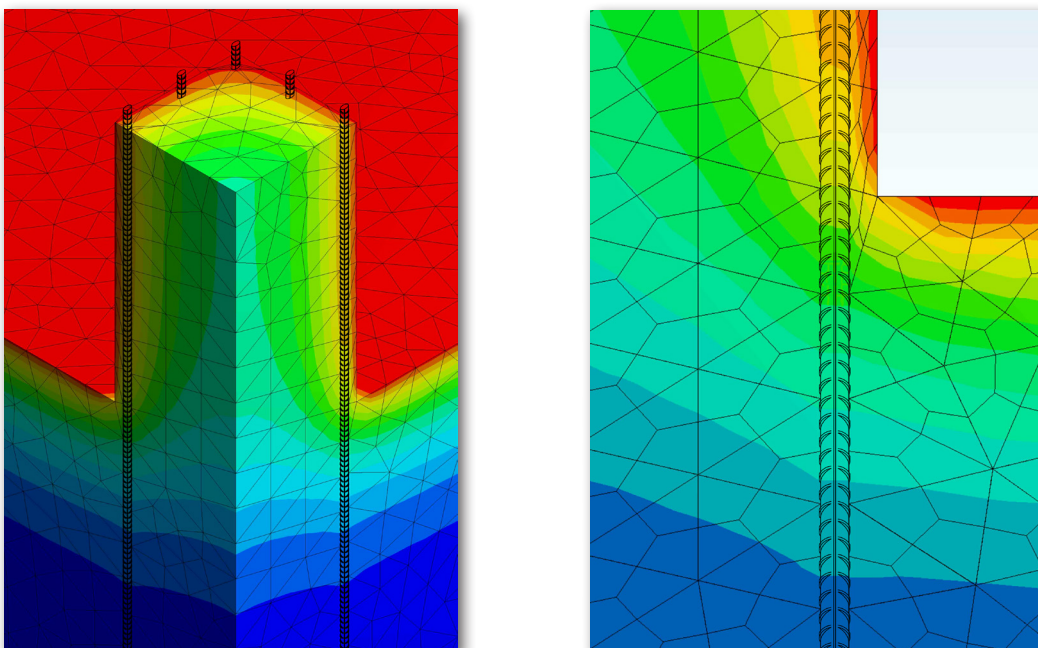

The fire model determines the heat distribution for rebars at the component corner (2 sides flamed) and at the component edge (1 side flamed).

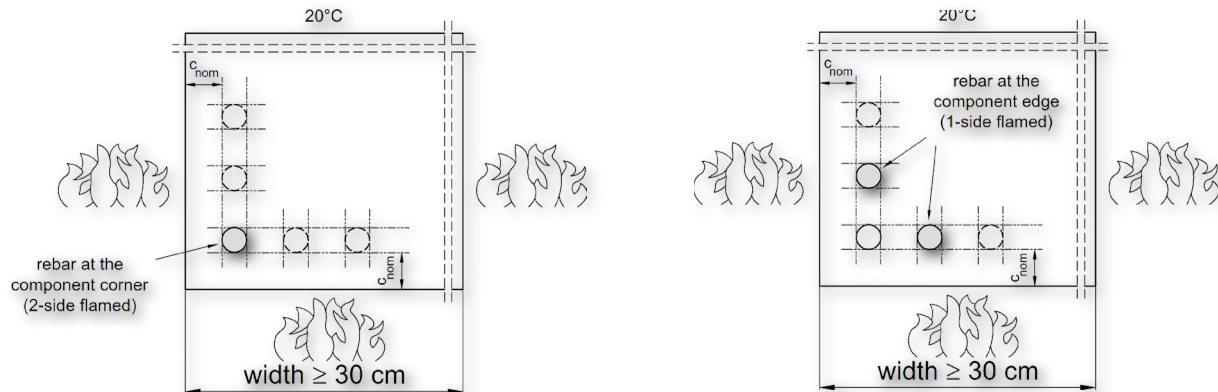

The effect of heat on the bond strength of the mortar was determined by tests and is expressed by the reduction factor $k_{b,fi}(\Theta)$ given in the ETA-20/0230.

The calculation of the required design lap length l_0 shall be carried out in accordance with EN 1992-1-1:2004+AC:2010, section 8.7.3 and the provisions of the ETA-20/0230 shall be met.

The design value of the bond strength $f_{bd,fi}$ under fire exposure has to be calculated by the following equation:

$$f_{bd,fi} = \bar{k}_{\Theta(x)} * f_{bd,PIR} * \gamma_c / \gamma_{M,fi} * f_{bd,fi,con} \leq f_{bd,PIR}$$

with:

$f_{bd,fi}$ = Design value of the bond strength under fire exposure in N/mm²

$\bar{k}_{\Theta(x)}$ = Mean reduction factor under fire exposure as a function of the temperature profile, given in the tables below

$f_{bd,PIR}$ = Design value of the bond strength in cold condition acc. ETA-20/0230, tab. C2 depending on concrete class, rebar diameter, drilling method and bonding range acc. EN 1992-1-1 in N/mm²

γ_c = Partial safety factor of concrete acc. EN 1992-1-1;
1,5 in absence of national regulation

$\gamma_{M,fi}$ = Partial safety factor of fire exposure acc. EN 1992-1-2;
1,0 in absence of national regulation

$f_{bd,fi,con}$ = Conversion factor taking into account the influence of the concrete class

The mean reduction factor $\bar{k}_{\Theta(x)}$ for e.g. beam on wall or column on slab applications for concrete covers of $c_{nom} = 10, 20, 30$ and 40 mm with the corresponding diameter of the rebar and fire-resistance grading at 30, 60, 90, 120, 180 or 240 min is given for a rebar at the edge (1 side flamed) or at the corner (2 sides flamed) in the following tables and valid for good bond conditions:

Endanchoring - Mean reduction factor under fire exposure $\bar{k}_{\Theta(x)}$ ³⁾												
$c_{nom} = 10 \text{ mm}$ ¹⁾	Rebar at the edge (1 side flamed)						Rebar at the corner (2 sides flamed)					
Rebar Ø8 - Ø20	Fire-resistance grading						Fire-resistance grading					
l_v ²⁾	R30	R60	R90	R120	R180	R240	R30	R60	R90	R120	R180	R240
[mm]	[-]	[-]	[-]	[-]	[-]	[-]	[-]	[-]	[-]	[-]	[-]	[-]
80	0,29	0,10	0,07	0,05	0,03	0,03	0,16	0,06	0,04	0,03	0,02	0,02
90	0,36	0,12	0,08	0,06	0,04	0,03	0,21	0,08	0,05	0,03	0,02	0,02
100	0,42	0,15	0,09	0,07	0,04	0,03	0,27	0,10	0,06	0,04	0,03	0,02
110	0,48	0,18	0,11	0,08	0,05	0,03	0,34	0,12	0,07	0,05	0,03	0,03
120	0,52	0,23	0,13	0,09	0,05	0,04	0,39	0,14	0,08	0,06	0,04	0,03
130	0,56	0,28	0,15	0,10	0,06	0,04	0,44	0,17	0,10	0,07	0,04	0,03
140	0,59	0,33	0,19	0,12	0,07	0,05	0,48	0,21	0,13	0,08	0,05	0,04
150	0,62	0,38	0,22	0,14	0,08	0,05	0,51	0,25	0,16	0,10	0,06	0,04
160	0,64	0,41	0,27	0,17	0,09	0,06	0,54	0,30	0,19	0,12	0,07	0,05
170	0,66	0,45	0,31	0,20	0,11	0,07	0,57	0,34	0,24	0,15	0,08	0,06
180	0,68	0,48	0,35	0,24	0,12	0,08	0,60	0,38	0,28	0,18	0,09	0,06
190	0,70	0,51	0,38	0,28	0,14	0,09	0,62	0,41	0,32	0,21	0,11	0,07
200	0,71	0,53	0,42	0,31	0,16	0,10	0,64	0,44	0,35	0,25	0,13	0,08
210	0,73	0,55	0,44	0,34	0,18	0,11	0,65	0,47	0,38	0,29	0,15	0,09
220	0,74	0,57	0,47	0,37	0,21	0,13	0,67	0,49	0,41	0,32	0,17	0,11
230	0,75	0,59	0,49	0,40	0,24	0,14	0,68	0,51	0,44	0,35	0,20	0,12
240	0,76	0,61	0,51	0,43	0,27	0,16	0,70	0,53	0,46	0,38	0,23	0,14
250	0,77	0,63	0,53	0,45	0,30	0,18	0,71	0,55	0,48	0,40	0,26	0,16
260	0,78	0,64	0,55	0,47	0,33	0,21	0,72	0,57	0,50	0,43	0,29	0,18
270	0,79	0,65	0,57	0,49	0,35	0,23	0,73	0,58	0,52	0,45	0,32	0,20
280	0,79	0,67	0,58	0,51	0,38	0,26	0,74	0,60	0,54	0,47	0,34	0,23
290	0,80	0,68	0,60	0,53	0,40	0,28	0,75	0,61	0,55	0,48	0,36	0,26
300	0,81	0,69	0,61	0,54	0,42	0,31	0,76	0,63	0,57	0,50	0,39	0,28
310	0,81	0,70	0,62	0,56	0,44	0,33	0,77	0,64	0,58	0,52	0,41	0,30
320	0,82	0,71	0,63	0,57	0,45	0,35	0,77	0,65	0,60	0,53	0,42	0,33
350	0,84	0,73	0,67	0,61	0,50	0,41	0,79	0,68	0,63	0,57	0,47	0,38
400	0,86	0,77	0,71	0,66	0,56	0,48	0,82	0,72	0,68	0,63	0,54	0,46
450	0,87	0,79	0,74	0,69	0,61	0,54	0,84	0,75	0,71	0,67	0,59	0,52
500	0,88	0,81	0,77	0,72	0,65	0,58	0,85	0,78	0,74	0,70	0,63	0,57
550	0,90	0,83	0,79	0,75	0,68	0,62	0,87	0,80	0,76	0,73	0,66	0,61
600	0,90	0,84	0,81	0,77	0,71	0,65	0,88	0,81	0,78	0,75	0,69	0,64
700	0,92	0,87	0,83	0,80	0,75	0,70	0,90	0,84	0,82	0,79	0,74	0,69
800	0,93	0,88	0,85	0,83	0,78	0,74	0,91	0,86	0,84	0,81	0,77	0,73
900	0,94	0,90	0,87	0,85	0,81	0,77	0,92	0,88	0,86	0,83	0,80	0,76
1000	0,94	0,91	0,88	0,86	0,83	0,79	0,93	0,89	0,87	0,85	0,82	0,78

¹⁾ c_{nom} = concrete cover

²⁾ l_v = embedment length of the bar in the concrete

³⁾ $\bar{k}_{\Theta(x)}$ = Mean reduction factor over the embedment depth of the rebar as a function of the temperature profile

Intermediate values of $\bar{k}_{\Theta(x)}$ may be interpolated linearly. Extrapolation is not permitted.

Endanchoring - Mean reduction factor under fire exposure $\bar{k}_{\theta(x)}$ ³⁾												
$c_{nom} = 20 \text{ mm}$ ¹⁾	Rebar at the edge (1 side flamed)						Rebar at the corner (2 sides flamed)					
Rebar $\varnothing 8 - \varnothing 20$	Fire-resistance grading						Fire-resistance grading					
l_v ²⁾	R30	R60	R90	R120	R180	R240	R30	R60	R90	R120	R180	R240
[mm]	[-]	[-]	[-]	[-]	[-]	[-]	[-]	[-]	[-]	[-]	[-]	[-]
80	0,38	0,14	0,09	0,06	0,04	0,03	0,20	0,08	0,05	0,04	0,03	0,02
90	0,43	0,16	0,10	0,07	0,04	0,03	0,24	0,09	0,06	0,04	0,03	0,02
100	0,49	0,18	0,11	0,07	0,05	0,03	0,28	0,10	0,07	0,05	0,03	0,03
110	0,53	0,21	0,12	0,08	0,05	0,04	0,33	0,12	0,07	0,05	0,04	0,03
120	0,57	0,23	0,13	0,09	0,06	0,04	0,38	0,14	0,08	0,06	0,04	0,03
130	0,60	0,27	0,15	0,10	0,06	0,04	0,43	0,16	0,10	0,07	0,04	0,03
140	0,63	0,30	0,17	0,11	0,07	0,05	0,47	0,19	0,11	0,08	0,05	0,04
150	0,66	0,35	0,19	0,13	0,07	0,05	0,51	0,22	0,13	0,09	0,06	0,04
160	0,68	0,39	0,22	0,14	0,08	0,06	0,54	0,26	0,14	0,10	0,06	0,04
170	0,70	0,42	0,24	0,16	0,09	0,06	0,56	0,30	0,17	0,11	0,07	0,05
180	0,71	0,46	0,28	0,18	0,10	0,07	0,59	0,34	0,19	0,13	0,08	0,05
190	0,73	0,48	0,31	0,20	0,11	0,07	0,61	0,37	0,22	0,15	0,09	0,06
200	0,74	0,51	0,35	0,23	0,12	0,08	0,63	0,40	0,25	0,17	0,10	0,07
210	0,76	0,53	0,38	0,25	0,14	0,09	0,65	0,43	0,29	0,19	0,11	0,07
220	0,77	0,55	0,41	0,28	0,15	0,10	0,66	0,46	0,32	0,22	0,12	0,08
230	0,78	0,57	0,43	0,32	0,17	0,11	0,68	0,48	0,35	0,25	0,14	0,09
240	0,79	0,59	0,46	0,34	0,19	0,12	0,69	0,50	0,38	0,28	0,15	0,10
250	0,79	0,61	0,48	0,37	0,21	0,13	0,70	0,52	0,40	0,31	0,17	0,11
260	0,80	0,62	0,50	0,39	0,23	0,15	0,72	0,54	0,43	0,33	0,20	0,13
270	0,81	0,64	0,52	0,42	0,26	0,16	0,73	0,56	0,45	0,36	0,22	0,14
280	0,82	0,65	0,53	0,44	0,28	0,18	0,74	0,57	0,47	0,38	0,25	0,16
290	0,82	0,66	0,55	0,46	0,31	0,20	0,74	0,59	0,49	0,40	0,27	0,18
300	0,83	0,67	0,56	0,48	0,33	0,22	0,75	0,60	0,50	0,42	0,30	0,20
310	0,83	0,68	0,58	0,49	0,35	0,24	0,76	0,62	0,52	0,44	0,32	0,22
320	0,84	0,69	0,59	0,51	0,37	0,26	0,77	0,63	0,53	0,46	0,34	0,24
350	0,85	0,72	0,63	0,55	0,43	0,33	0,79	0,66	0,57	0,51	0,40	0,31
400	0,87	0,75	0,67	0,61	0,50	0,41	0,82	0,70	0,63	0,57	0,47	0,39
500	0,90	0,80	0,74	0,69	0,60	0,53	0,85	0,76	0,70	0,65	0,58	0,52
600	0,91	0,84	0,78	0,74	0,67	0,61	0,88	0,80	0,75	0,71	0,65	0,60
700	0,93	0,86	0,81	0,78	0,71	0,66	0,89	0,83	0,79	0,75	0,70	0,65
800	0,94	0,88	0,84	0,80	0,75	0,71	0,91	0,85	0,81	0,78	0,74	0,70
900	0,94	0,89	0,85	0,83	0,78	0,74	0,92	0,87	0,83	0,81	0,77	0,73
1000	0,95	0,90	0,87	0,84	0,80	0,76	0,93	0,88	0,85	0,83	0,79	0,76
1500	0,97	0,93	0,91	0,90	0,87	0,84	0,95	0,92	0,90	0,88	0,86	0,84
2000	0,97	0,95	0,93	0,92	0,90	0,88	0,96	0,94	0,93	0,91	0,89	0,88

¹⁾ c_{nom} = concrete cover

²⁾ l_v = embedment length of the bar in the concrete

³⁾ $\bar{k}_{\theta(x)}$ = Mean reduction factor over the embedment depth of the rebar as a function of the temperature profile

Intermediate values of $\bar{k}_{\theta(x)}$ may be interpolated linearly. Extrapolation is not permitted.

Endanchoring - Mean reduction factor under fire exposure $\bar{k}_{\theta(x)}$ ³⁾												
$c_{nom} = 30 \text{ mm}$ ¹⁾	Rebar at the edge (1 side flamed)						Rebar at the corner (2 sides flamed)					
Rebar Ø8 - Ø28	Fire-resistance grading						Fire-resistance grading					
l_v ²⁾	R30	R60	R90	R120	R180	R240	R30	R60	R90	R120	R180	R240
[mm]	[-]	[-]	[-]	[-]	[-]	[-]	[-]	[-]	[-]	[-]	[-]	[-]
80	0,59	0,20	0,11	0,08	0,05	0,03	0,33	0,11	0,07	0,05	0,03	0,03
90	0,64	0,22	0,12	0,08	0,05	0,04	0,37	0,12	0,07	0,05	0,04	0,03
100	0,68	0,24	0,13	0,09	0,05	0,04	0,42	0,14	0,08	0,06	0,04	0,03
110	0,71	0,27	0,15	0,10	0,06	0,04	0,47	0,15	0,09	0,06	0,04	0,03
120	0,73	0,29	0,16	0,11	0,06	0,04	0,51	0,17	0,10	0,07	0,05	0,03
130	0,75	0,32	0,17	0,11	0,07	0,05	0,55	0,19	0,11	0,08	0,05	0,04
140	0,77	0,36	0,19	0,12	0,07	0,05	0,58	0,22	0,12	0,08	0,05	0,04
150	0,78	0,39	0,21	0,14	0,08	0,05	0,61	0,25	0,14	0,09	0,06	0,04
160	0,80	0,43	0,23	0,15	0,08	0,06	0,63	0,28	0,15	0,10	0,06	0,05
170	0,81	0,46	0,25	0,16	0,09	0,06	0,66	0,31	0,17	0,11	0,07	0,05
180	0,82	0,49	0,28	0,18	0,10	0,07	0,68	0,35	0,19	0,13	0,08	0,05
190	0,83	0,52	0,31	0,19	0,11	0,07	0,69	0,38	0,21	0,14	0,08	0,06
200	0,84	0,55	0,34	0,21	0,11	0,08	0,71	0,41	0,24	0,16	0,09	0,06
210	0,85	0,57	0,37	0,23	0,12	0,08	0,72	0,44	0,27	0,17	0,10	0,07
220	0,85	0,59	0,40	0,26	0,14	0,09	0,73	0,47	0,30	0,19	0,11	0,08
230	0,86	0,60	0,42	0,28	0,15	0,10	0,75	0,49	0,33	0,22	0,12	0,08
240	0,86	0,62	0,45	0,31	0,16	0,10	0,76	0,51	0,36	0,24	0,13	0,09
250	0,87	0,64	0,47	0,34	0,18	0,11	0,77	0,53	0,38	0,27	0,15	0,10
260	0,88	0,65	0,49	0,36	0,19	0,12	0,78	0,55	0,41	0,30	0,16	0,11
270	0,88	0,66	0,51	0,39	0,21	0,13	0,78	0,57	0,43	0,32	0,18	0,12
280	0,88	0,68	0,53	0,41	0,23	0,15	0,79	0,58	0,45	0,35	0,20	0,13
290	0,89	0,69	0,54	0,43	0,25	0,16	0,80	0,60	0,47	0,37	0,22	0,14
300	0,89	0,70	0,56	0,45	0,28	0,17	0,81	0,61	0,48	0,39	0,24	0,16
310	0,90	0,71	0,57	0,46	0,30	0,19	0,81	0,62	0,50	0,41	0,27	0,17
320	0,90	0,72	0,58	0,48	0,32	0,20	0,82	0,63	0,52	0,43	0,29	0,19
350	0,91	0,74	0,62	0,53	0,38	0,26	0,83	0,66	0,56	0,48	0,35	0,25
400	0,92	0,77	0,67	0,59	0,46	0,35	0,85	0,71	0,61	0,54	0,43	0,34
500	0,94	0,82	0,73	0,67	0,57	0,48	0,88	0,77	0,69	0,63	0,55	0,47
600	0,95	0,85	0,78	0,72	0,64	0,57	0,90	0,80	0,74	0,70	0,62	0,56
700	0,95	0,87	0,81	0,76	0,69	0,63	0,92	0,83	0,78	0,74	0,68	0,62
800	0,96	0,89	0,83	0,79	0,73	0,68	0,93	0,85	0,81	0,77	0,72	0,67
900	0,96	0,90	0,85	0,82	0,76	0,71	0,94	0,87	0,83	0,80	0,75	0,71
1000	0,97	0,91	0,87	0,83	0,78	0,74	0,94	0,88	0,85	0,82	0,77	0,74
1500	0,98	0,94	0,91	0,89	0,86	0,83	0,96	0,92	0,90	0,88	0,85	0,82
2000	0,98	0,95	0,93	0,92	0,89	0,87	0,97	0,94	0,92	0,91	0,89	0,87

¹⁾ c_{nom} = concrete cover

²⁾ l_v = embedment length of the bar in the concrete

³⁾ $\bar{k}_{\theta(x)}$ = Mean reduction factor over the embedment depth of the rebar as a function of the temperature profile

Intermediate values of $\bar{k}_{\theta(x)}$ may be interpolated linearly. Extrapolation is not permitted.

Endanchoring - Mean reduction factor under fire exposure $\bar{k}_{\theta(x)}$ ³⁾												
$c_{nom} = 40 \text{ mm}$ ¹⁾	Rebar at the edge (1 side flamed)						Rebar at the corner (2 sides flamed)					
Rebar $\varnothing 8 - \varnothing 40$	Fire-resistance grading						Fire-resistance grading					
l_v ²⁾	R30	R60	R90	R120	R180	R240	R30	R60	R90	R120	R180	R240
[mm]	[-]	[-]	[-]	[-]	[-]	[-]	[-]	[-]	[-]	[-]	[-]	[-]
80	0,87	0,29	0,15	0,10	0,06	0,04	0,58	0,17	0,10	0,07	0,04	0,03
90	0,88	0,31	0,16	0,10	0,06	0,04	0,62	0,19	0,10	0,07	0,04	0,03
100	0,89	0,33	0,17	0,11	0,06	0,04	0,66	0,20	0,11	0,08	0,05	0,04
110	0,90	0,35	0,18	0,12	0,06	0,05	0,69	0,22	0,12	0,08	0,05	0,04
120	0,91	0,38	0,19	0,12	0,07	0,05	0,72	0,24	0,13	0,09	0,05	0,04
130	0,92	0,41	0,21	0,13	0,07	0,05	0,74	0,26	0,14	0,09	0,06	0,04
140	0,92	0,44	0,22	0,14	0,08	0,05	0,76	0,28	0,15	0,10	0,06	0,04
150	0,93	0,47	0,24	0,15	0,08	0,06	0,77	0,31	0,16	0,11	0,06	0,05
160	0,93	0,50	0,25	0,16	0,09	0,06	0,79	0,34	0,18	0,12	0,07	0,05
170	0,94	0,53	0,27	0,17	0,09	0,06	0,80	0,37	0,19	0,13	0,07	0,05
180	0,94	0,56	0,29	0,18	0,10	0,06	0,81	0,40	0,21	0,14	0,08	0,06
190	0,94	0,58	0,31	0,19	0,10	0,07	0,82	0,43	0,23	0,15	0,09	0,06
200	0,95	0,60	0,34	0,21	0,11	0,07	0,83	0,46	0,25	0,16	0,09	0,06
210	0,95	0,62	0,36	0,22	0,12	0,08	0,84	0,49	0,27	0,17	0,10	0,07
220	0,95	0,64	0,39	0,24	0,12	0,08	0,85	0,51	0,30	0,19	0,11	0,07
230	0,95	0,65	0,42	0,26	0,13	0,09	0,85	0,53	0,32	0,21	0,11	0,08
240	0,96	0,67	0,44	0,27	0,14	0,09	0,86	0,55	0,35	0,22	0,12	0,08
250	0,96	0,68	0,46	0,30	0,15	0,10	0,86	0,57	0,38	0,24	0,13	0,09
260	0,96	0,69	0,48	0,32	0,16	0,10	0,87	0,59	0,40	0,26	0,14	0,10
270	0,96	0,71	0,50	0,34	0,17	0,11	0,87	0,60	0,42	0,29	0,15	0,10
280	0,96	0,72	0,52	0,36	0,19	0,12	0,88	0,62	0,44	0,31	0,17	0,11
290	0,96	0,73	0,54	0,39	0,20	0,13	0,88	0,63	0,46	0,34	0,18	0,12
300	0,96	0,74	0,55	0,41	0,21	0,13	0,89	0,64	0,48	0,36	0,20	0,13
310	0,97	0,74	0,57	0,43	0,23	0,14	0,89	0,65	0,50	0,38	0,21	0,14
320	0,97	0,75	0,58	0,44	0,24	0,15	0,89	0,66	0,51	0,40	0,23	0,15
350	0,97	0,77	0,62	0,49	0,30	0,19	0,90	0,69	0,55	0,45	0,29	0,18
400	0,97	0,80	0,66	0,55	0,39	0,26	0,92	0,73	0,61	0,52	0,38	0,26
500	0,98	0,84	0,73	0,64	0,51	0,40	0,93	0,79	0,69	0,61	0,50	0,41
600	0,98	0,87	0,78	0,70	0,59	0,50	0,94	0,82	0,74	0,68	0,58	0,51
700	0,98	0,89	0,81	0,75	0,65	0,57	0,95	0,85	0,78	0,72	0,64	0,58
800	0,99	0,90	0,83	0,78	0,69	0,63	0,96	0,87	0,81	0,76	0,69	0,63
900	0,99	0,91	0,85	0,80	0,73	0,67	0,96	0,88	0,83	0,79	0,72	0,67
1000	0,99	0,92	0,87	0,82	0,75	0,70	0,97	0,89	0,84	0,81	0,75	0,70
1500	0,99	0,95	0,91	0,88	0,84	0,80	0,98	0,93	0,90	0,87	0,83	0,80
2000	0,99	0,96	0,93	0,91	0,88	0,85	0,98	0,95	0,92	0,90	0,88	0,85

¹⁾ c_{nom} = concrete cover

²⁾ l_v = embedment length of the bar in the concrete

³⁾ $\bar{k}_{\theta(x)}$ = Mean reduction factor over the embedment depth of the rebar as a function of the temperature profile

Intermediate values of $\bar{k}_{\theta(x)}$ may be interpolated linearly. Extrapolation is not permitted.

The bond strength $f_{bd,PIR}$ depends on the concrete class and rebar diameter as well as on the corresponding conversion factor $f_{bd,fi,con}$ and can be found for rebar at the corner and the edge in the following table:

Concrete class	Ø-Rebar	$f_{bd,PIR}$ (all drilling methods)	$f_{bd,fi,con}$ - Factor
[-]	[mm]	[N/mm ²]	[-]
C12/15	Ø8 - Ø34	1,6	1,44
	Ø36, Ø40	1,5	1,53
C16/20	Ø8 - Ø34	2,0	1,15
	Ø36	1,9	1,21
	Ø40	1,8	1,28
C20/25	Ø8 - Ø34	2,3	1,00
	Ø36	2,2	1,05
	Ø40	2,1	1,10
C25/30	Ø8 - Ø32	2,7	0,85
	Ø34, Ø36	2,6	0,88
	Ø40	2,5	0,92
C30/37	Ø8 - Ø32	3,0	0,77
	Ø34, Ø36	2,9	0,79
	Ø40	2,8	0,82
C35/45	Ø8 - Ø32	3,4	0,68
	Ø34, Ø36	3,3	0,70
	Ø40	3,1	0,74
C40/50	Ø8 - Ø32	3,7	0,62
	Ø34, Ø36	3,6	0,64
	Ø40	3,4	0,68
C45/55	Ø8 - Ø32	4,0	0,58
	Ø34	3,9	0,59
	Ø36	3,8	0,61
	Ø40	3,7	0,62
C50/60	Ø8 - Ø32	4,3	0,53
	Ø34	4,2	0,55
	Ø36	4,1	0,56
	Ø40	4,0	0,58

The given values does not deal with the mechanical design at ambient temperature, these shall be done in addition and related to ETA-20/0230.

Post-installed rebar connections shall be designed in ambient temperature conditions before being designed in fire conditions.

The bond resistance $f_{bd,fi}$ shall not be applied for beam to beam connections.

The partial safety factor for actions can be assumed to be $\gamma_F = 1.0$ for determining recommended loads.

Post installed rebar according to TR 069

For the first time, EOTA Technical Report 069 provides a design basis for the construction of rigid concrete-concrete connections by means of post-installed reinforcement connections, in which connection reinforcement in the existing structure and thus large-area concrete removal can be dispensed with (see illustration). This design basis only applies to the local load introduction into the concrete and must be harmonised with the requirements of EN 1992-1-1, among others. Reinforced and unreinforced concrete of strength class C20/25 to C50/60 is considered for a service life of 50 or 100 years. With the design according to TR 069, higher design values of the bond stress are possible with increasing concrete cover compared to the design according to EN 1992-1-1.

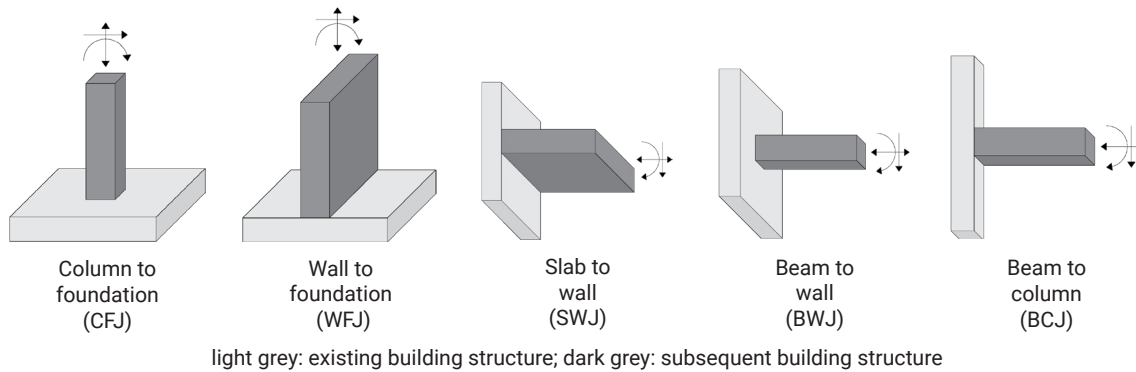

This makes applications with lower component thicknesses or lower realisable anchorage depths possible in the first place.

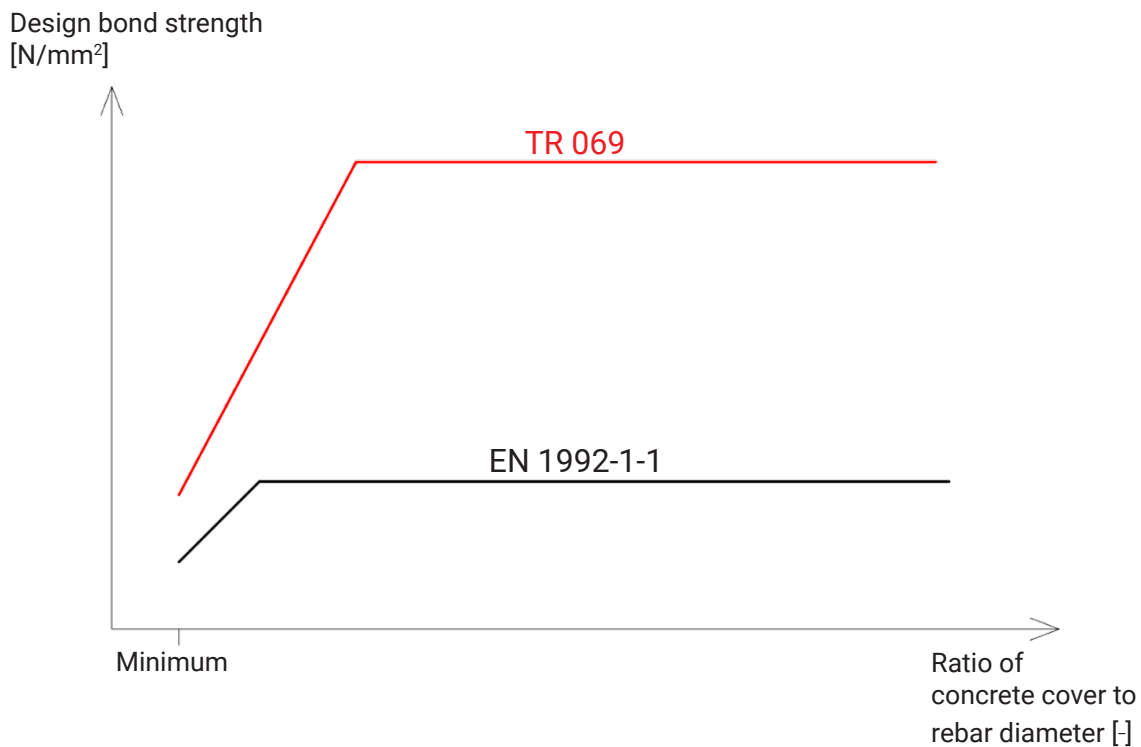

Characteristic resistance HD/CD/HDB

Characteristic values of the tensile load-bearing capacity under static and quasistatic load in hammer-drilled holes (HD), in holes drilled with compressed air (CD) and in hammer-drilled holes with hollow drill bit (HDB). Service life 50 and 100 years. The specified characteristic resistances apply to rigid concrete-concrete connections with a subsequent reinforcement connection in accordance with EOTA TR 069 under static and quasistatic loads.

Reinforcing bar				Ø8	Ø10	Ø12	Ø14	Ø16	Ø20	Ø24	Ø25	Ø28	Ø32	Ø36	Ø40	
Combined pull-out and concrete failure; working life 50 and 100 years																
Characteristic resistance in uncracked concrete C20/25 in hammer drilled holes (HD) and compressed air drilled holes (CD)																
Temperature range	I: 24°C / 40°C	Dry, wet concrete and flooded bore hole	$\tau_{Rk,ucr,50} = \tau_{Rk,ucr,100}$	[N/mm ²]	16	16	16	16	16	15	15	15	15	15	15	
	II: 50°C / 72°C				12	12	12	12	12	12	12	11	11	11	11	11
Characteristic resistance in uncracked concrete C20/25 in hammer drilled holes with hollow drill bit (HDB)																
Temperature range	I: 24°C / 40°C	Dry, wet concrete	$\tau_{Rk,ucr,50} = \tau_{Rk,ucr,100}$	[N/mm ²]	14	14	13	13	13	13	13	13	13	13	NPA	
	II: 50°C / 72°C				12	12	12	11	11	11	11	11	11			
	I: 24°C / 40°C	flooded bore hole			13	13	13	13	13	13	13	13	13			
	II: 50°C / 72°C				11	11	11	11	11	11	11	11	11			
Reduction factor $\psi_{sus,50}^0, \psi_{sus,100}^0$ in cracked and uncracked concrete C20/25; (HD, CD and HDB)																
Temperature range	I: 24°C / 40°C	Dry, wet concrete and flooded bore hole	$\psi_{sus,50}^0 = \psi_{sus,100}^0$	[-]	0.8											
	II: 50°C / 72°C				0.68											
Increasing factors for concrete			ψ_c	[-]	$(f_{ck}/20)^{0.1}$											
Characteristic bond resistance depending on the concrete strength class			$\tau_{Rk,ucr,50} =$	$\psi_c \cdot \tau_{Rk,ucr,50,(C20/25)}$												
			$\tau_{Rk,ucr,100} =$	$\psi_c \cdot \tau_{Rk,ucr,100,(C20/25)}$												
Influence of cracked concrete on combined pullout and concrete cone failure; working life of 50 and 100 years; (HD, CD and HDB)																
Factor for influence of cracked concrete	HD, CD	Ω_{cr}	[-]	0.84	0.84	0.85	0.86	0.87	0.89	0.91	0.91	0.92	0.94	0.94	0.95	
	HDB			0.84	0.84	0.85	0.86	0.87	0.89	0.91	0.91	0.92	0.94	NPA		
Bond-splitting failure; working life 50 and 100 years; (HD, CD and HDB)																
Product basic factor			A_k	[-]	6.0											
Exponent for influence of...																
- concrete compressive strength			sp1	[-]	0.32											
- rebar diameter Ø			sp2	[-]	0.60											
- concrete cover c_d			sp3	[-]	0.30											
- side concrete cover (c_{max} / c_d)			sp4	[-]	0.28											
- embedment length l_b			lb1	[-]	0.66											
Concrete cone failure																
Relevant parameter			see Table C1													
Installation factor; (HD, CD and HDB)																
for dry and wet concrete			γ_{inst}	[-]	1.0											1.2
for flooded bore hole					1.2											NPA

Characteristic resistance DD

Characteristic values of the tensile load-bearing capacity under static and quasistatic loading of diamond-drilled holes (DD). Service life 50 and 100 years. The specified characteristic resistances apply to rigid concrete-concrete connections with a subsequent reinforcement connection in accordance with EOTA TR 069 under static and quasistatic loads.

Reinforcing bar				Ø8	Ø10	Ø12	Ø14	Ø16	Ø20	Ø24	Ø25	Ø28	Ø32	Ø36	Ø40	
Combined pull-out and concrete failure																
Characteristic resistance in uncracked concrete C20/25; working life 50 years																
Temperature range	I: 24°C / 40°C	Dry, wet concrete and flooded bore hole	$\tau_{Rk,ucr,50}$	[N/mm ²]	14	13	13	13	12	12	11	11	11	11	10	
	II: 50°C / 72°C				11	11	10	10	10	9.5	9.5	9.5	9.0	9.0	8.5	8.5
Reduction factor $\psi_{sus,50}^0$ in cracked and uncracked concrete C20/25; working life 50 years																
Temperature range	I: 24°C / 40°C	Dry, wet concrete and flooded bore hole	$\psi_{sus,50}^0$	[-]	0.77											
	II: 50°C / 72°C				0.72											
Characteristic resistance in uncracked concrete C20/25; working life 100 years																
Temperature range	I: 24°C / 40°C	Dry, wet concrete and flooded bore hole	$\tau_{Rk,ucr,100}$	[N/mm ²]	14	13	13	13	12	12	11	11	11	11	10	
	II: 50°C / 72°C				11	10	10	10	9.5	9.0	9.0	9.0	8.5	8.5	8.0	8.0
Reduction factor $\psi_{sus,100}^0$ in cracked and uncracked concrete C20/25; working life 100 years																
Temperature range	I: 24°C / 40°C	Dry, wet concrete and flooded bore hole	$\psi_{sus,100}^0$	[-]	0.73											
	II: 50°C / 72°C				0.70											
Increasing factors for concrete			ψ_c	[-]	$(f_{ck}/20)^{0.2}$											
Characteristic bond resistance depending on the concrete strength class			$\tau_{Rk,ucr,50} =$		$\psi_c \cdot \tau_{Rk,ucr,50,(C20/25)}$											
					$\psi_c \cdot \tau_{Rk,ucr,100,(C20/25)}$											
Influence of cracked concrete on combined pullout and concrete cone failure; working life 50 and 100 years																
Factor for influence of cracked concrete			Ω_{cr}	[-]	0.87	0.88	0.89	0.90	0.91	0.94	0.94	0.94	0.93	0.93	0.93	
Bond-splitting failure; working life 50 and 100 years																
Product basic factor			A_k	[-]	5.9											
Exponent for influence of...																
- concrete compressive strength			sp1	[-]	0.28											
- rebar diameter Ø			sp2	[-]	0.53											
- concrete cover c_d			sp3	[-]	0.36											
- side concrete cover (c_{max} / c_d)			sp4	[-]	0.29											
- embedment length l_b			lb1	[-]	0.65											
Concrete cone failure																
Relevant parameter			see Table C1													
Installation factor																
for dry and wet concrete			γ_{inst}	[-]	1.0											1.2
for flooded bore hole					1.2	1.4										