

Approval body for construction products  
and types of construction

Bautechnisches Prüfamt

An institution established by the Federal and  
Laender Governments



## European Technical Assessment

ETA-16/0439  
of 7 August 2019

English translation prepared by DIBt - Original version in German language

### General Part

Technical Assessment Body issuing the  
European Technical Assessment:

Deutsches Institut für Bautechnik

Trade name of the construction product

Concrete screw BSZ

Product family  
to which the construction product belongs

Fasteners for use in concrete for redundant  
non-structural systems

Manufacturer

MKT  
Metall-Kunststoff-Technik GmbH & Co. KG  
Auf dem Immel 2  
67685 Weilerbach  
DEUTSCHLAND

Manufacturing plant

MKT Werk 5, D

This European Technical Assessment  
contains

16 pages including 3 annexes which form an integral part  
of this assessment

This European Technical Assessment is  
issued in accordance with Regulation (EU)  
No 305/2011, on the basis of

EAD 330747-00-0601

This version replaces

ETA-16/0439 issued on 8 August 2016

The European Technical Assessment is issued by the Technical Assessment Body in its official language. Translations of this European Technical Assessment in other languages shall fully correspond to the original issued document and shall be identified as such.

Communication of this European Technical Assessment, including transmission by electronic means, shall be in full. However, partial reproduction may only be made with the written consent of the issuing Technical Assessment Body. Any partial reproduction shall be identified as such.

This European Technical Assessment may be withdrawn by the issuing Technical Assessment Body, in particular pursuant to information by the Commission in accordance with Article 25(3) of Regulation (EU) No 305/2011.

## Specific Part

### 1 Technical description of the product

The concrete screw BSZ in sizes of 5 and 6 mm is an anchor made of zinc-plated steel respectively steel with zinc flake coating and stainless steel. The anchor is screwed into a predrilled cylindrical drill hole. The special thread of the anchor cuts an internal thread into the member while setting. The anchorage is characterised by mechanical interlock in the special thread.

Product and product description is given in Annex A.

### 2 Specification of the intended use in accordance with the applicable European Assessment Document

The performances given in Section 3 are only valid if the anchor is used in compliance with the specifications and conditions given in Annex B.

The verifications and assessment methods on which this European Technical Assessment is based lead to the assumption of a working life of the anchor of at least 50 years. The indications given on the working life cannot be interpreted as a guarantee given by the producer, but are to be regarded only as a means for choosing the right products in relation to the expected economically reasonable working life of the works.

### 3 Performance of the product and references to the methods used for its assessment

#### 3.1 Safety in case of fire (BWR 2)

Essential characteristic	Performance
Reaction to fire	Class A1
Resistance to fire	See Annex C 3

#### 3.2 Safety in use (BWR 4)

Essential characteristic	Performance
Characteristic resistance to tension load (static and quasi-static loading)	See Annex C 1
Characteristic resistance to shear load (static and quasi-static loading)	See Annex C 1
Characteristic resistance for all load directions and modes of failure for simplified design	See Annex C 2
Durability	See Annex B 1

### 4 Assessment and verification of constancy of performance (AVCP) system applied, with reference to its legal base

In accordance with European Assessment Document EAD No. 330747-00-0601, the applicable European legal act is: [97/161/EC].

The system to be applied is: 2+

**5 Technical details necessary for the implementation of the AVCP system, as provided for in the applicable European Assessment Document**

Technical details necessary for the implementation of the AVCP system are laid down in the control plan deposited at Deutsches Institut für Bautechnik.

Issued in Berlin on 7 August 2019 by Deutsches Institut für Bautechnik

BD Dipl.-Ing. Andreas Kummerow  
Head of Department

*beglaubigt:*  
Baderschneider

## Concrete Screw BSZ

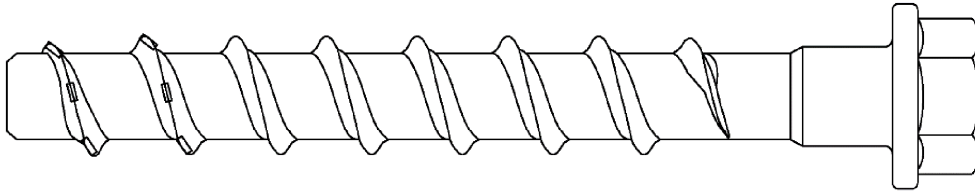

BSZ zinc plated  
BSZ A4  
BSZ HCR

## Installation situation in concrete

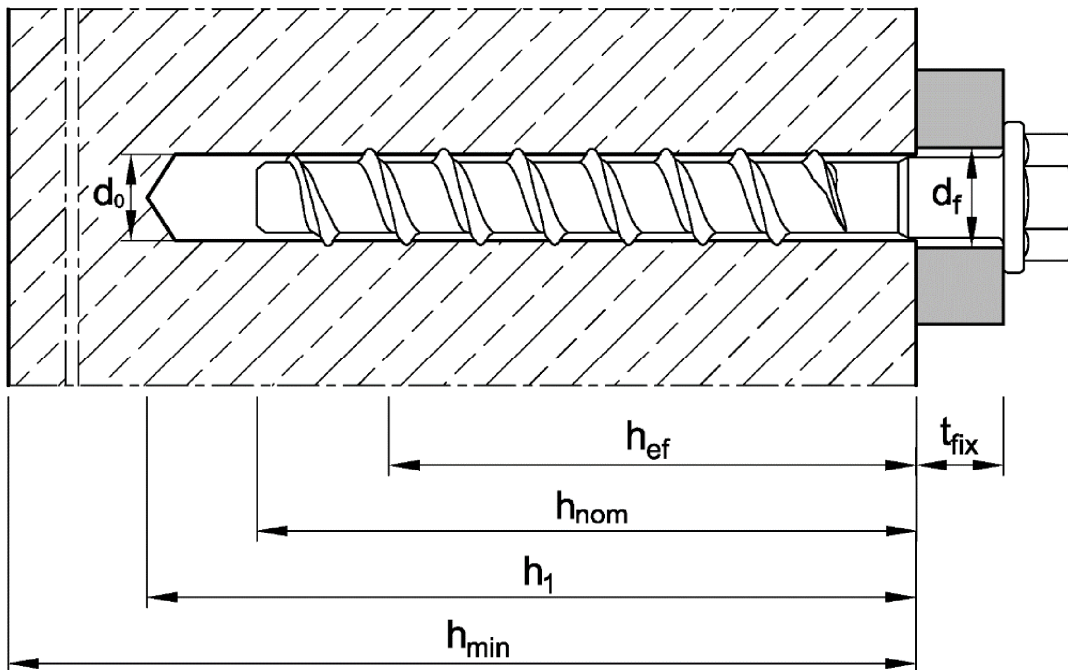

- $d_0$  = nominal drill bit diameter
- $h_{ef}$  = effective anchorage depth
- $h_{nom}$  = nominal anchorage depth
- $h_1$  = depth of the drill hole
- $h_{min}$  = minimum thickness of member
- $t_{fix}$  = thickness of fixture
- $d_f$  = diameter of clearance hole in the fixture

## Concrete Screw BSZ

### Product description

Product and installation situation in concrete

Annex A1

### Installation situation in precast hollow core slabs

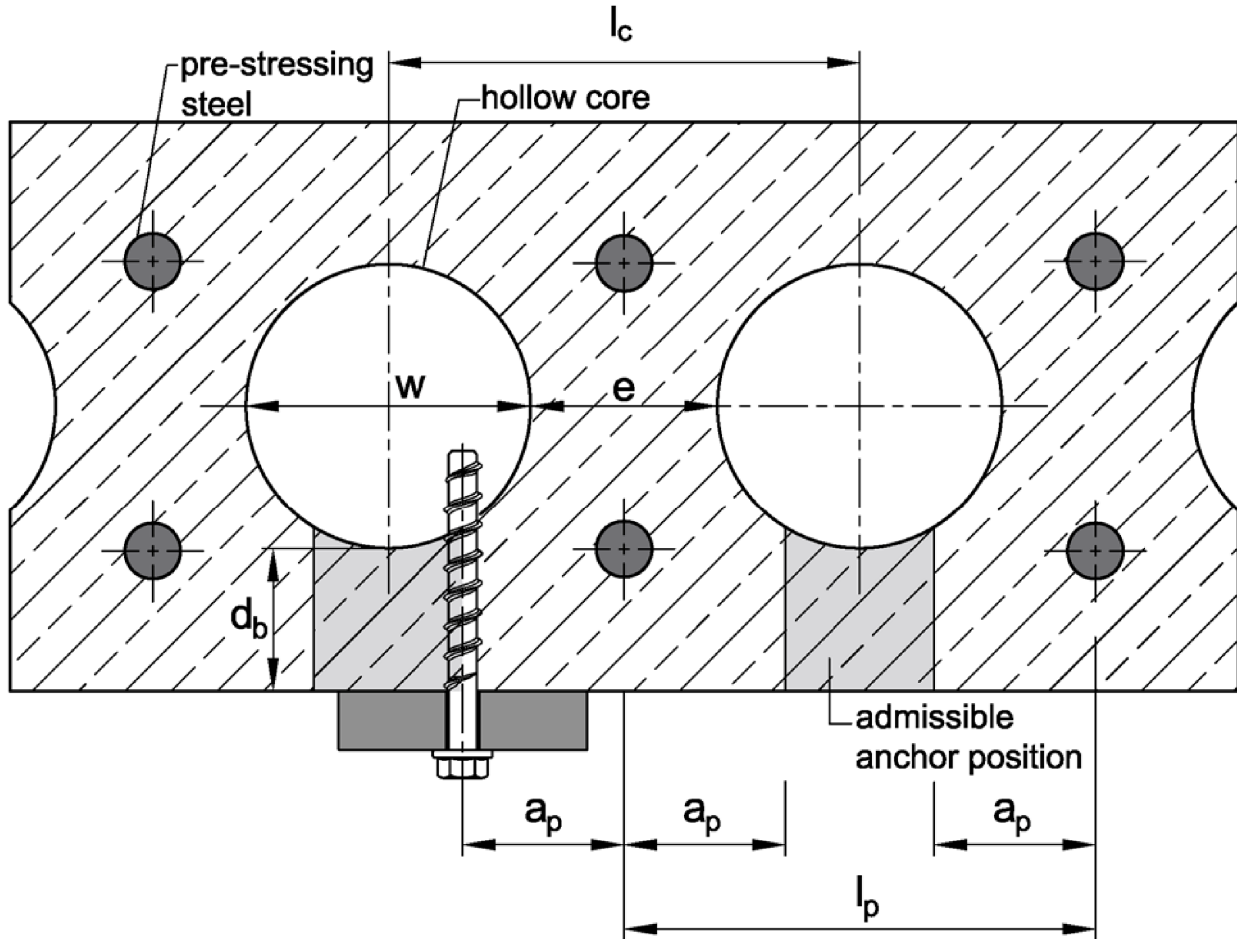

$$w / e \leq 4,2$$

w = core width

e = web thickness

d<sub>b</sub> = Flange thickness

l<sub>c</sub> = Core distance

l<sub>p</sub> = Pre-stressing steel distance

a<sub>p</sub> = Distance between anchor position and  
pre-stressing steel

l<sub>c</sub> ≥ 100 mm

l<sub>p</sub> ≥ 100 mm

a<sub>p</sub> ≥ 50 mm

#### Concrete Screw BSZ

Product description  
Installation situation

Annex A2

**Table A1: Anchor types and description**

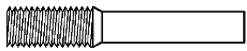
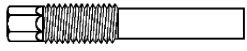
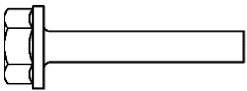
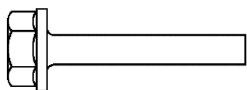
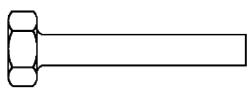
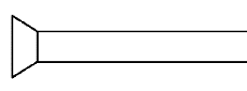
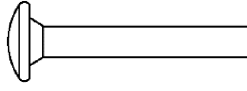
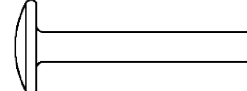
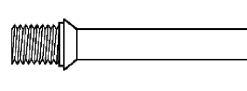
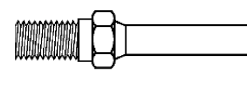
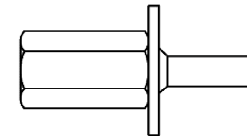
Anchor type	BSZ -	Description
1 	<b>BI</b>	Anchor version with metric connection thread and hexagon socket
2 	<b>B</b>	Anchor version with metric connection thread and hexagon drive
3 	<b>SU...TX</b>	Anchor version with hexagon head, pressed-on washer and TORX drive
4 	<b>SU</b>	Anchor version with hexagon head and pressed-on washer
5 	<b>S</b>	Anchor version with hexagon head
6 	<b>SK</b>	Anchor version with countersunk head and TORX drive
7 	<b>LK</b>	Anchor version with pan head and TORX drive
8 	<b>GLK</b>	Anchor version with large pan head and TORX drive
9 	<b>BSK</b>	Anchor version with countersunk head and metric connection thread
10 	<b>BS</b>	Anchor version with hexagon drive and metric connection thread
11 	<b>M</b>	Anchor version with internal thread and hexagon drive

**Concrete Screw BSZ**

**Product description**  
Anchor types and description

**Annex A3**

**Table A2: Dimensions**

Anchor size			BSZ 5	BSZ 6
Length of the anchor	$L \leq$	[mm]	200	
Thread	Core diameter	$d_k$	[mm]	4,0
	Outside diameter	$d_s$	[mm]	6,5

**Marking** e.g.:  $\diamond$  BSZ 6 100  
or TSM 6 100

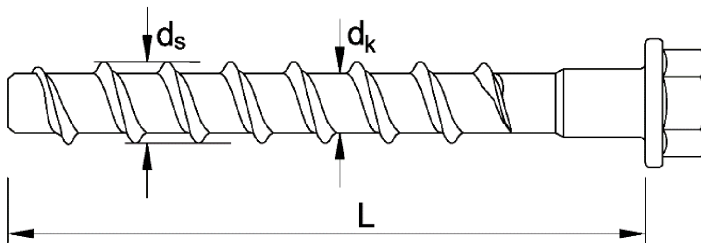

$\diamond$  BSZ Trade name  
or TSM (optional with manufacturer identification  $\diamond$ )

6 Anchor size

100 Length of anchor

A4 additional marking of stainless steel

HCR additional marking of high corrosion resistant steel

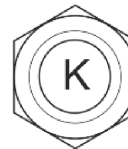

„k“ or „x“ for anchors with connection thread and  $h_{nom} = 35$  mm

**Table A3: Materials**

Version	Steel, zinc plated BSZ	Stainless steel BSZ A4	High corrosion resistant steel BSZ HCR
<b>Material</b>	Steel EN 10263-4:2017 galvanized acc. to EN ISO 4042:2018 or zinc flake coating acc. to EN ISO 10683:2018 ( $\geq 5\mu\text{m}$ )	1.4401, 1.4404, 1.4571, 1.4578	1.4529
Nominal characteristic steel yield strength $f_{yk}$	560 N/mm <sup>2</sup>		
Nominal characteristic steel ultimate strength $f_{uk}$	700 N/mm <sup>2</sup>		
Elongation at fracture $A_s$	$\leq 8\%$		

**Concrete Screw BSZ**

**Product description**  
Dimensions, marking and materials

**Annex A4**



## Specifications of Intended use

Concrete screw BSZ		BSZ 5	BSZ 6
Anchorage subject to	<b>Redundant non-structural systems</b> according to EN 1992-4:2018	✓	✓
	Static or quasi-static loads	✓	✓
	Fire exposure in solid concrete	-	✓
Base material	Cracked or uncracked concrete	✓	✓
	Compacted, reinforced or unreinforced concrete (without fibres) according to EN 206:2013	✓	✓
	Strength classes according to EN 206:2013: C20/25 to C50/60	✓	✓
	Precast pre-stressed hollow core slabs: C30/37 to C50/60	-	✓

### Use conditions (Environmental conditions):

- Structures subject to dry internal conditions (zinc plated steel, stainless steel or high corrosion resistant steel).
- Structures subject to external atmospheric exposure including industrial and marine environment or exposure to permanently damp internal condition, if no particular aggressive conditions exist (stainless steel or high corrosion resistant steel).
- Structures subject to external atmospheric exposure and to permanently damp internal condition, if other particular aggressive conditions exist (high corrosion resistant steel)

Note: Particular aggressive conditions are e.g. permanent, alternation immersion in seawater or the splash zone of seawater, chloride atmosphere of indoor pools or atmosphere with extreme chemical pollution (e.g. in desulphurization plants or road tunnels where de-icing materials are used).

### Design:

- Anchorage are designed under the responsibility of an engineer experienced in anchorages and concrete work.
- Verifiable calculation notes and drawings are prepared taking account of the loads to be anchored. The position of the anchor is indicated on the design drawings (e.g. position of the anchor relative to reinforcement or to supports, etc.).
- Design method for anchorages acc. to EN 1992-4:2018 and EOTA Technical Report TR 055:
  - Anchorage in solid concrete: design method A
  - Anchorage in precast pre-stressed hollow core slabs: design method C
  - The design method for shear load also applies for the specified diameter  $d_f$  of the clearance hole in the fixture in Annex B2, Table B1.

### Installation:

- Making of drill hole by hammer drilling or vacuum drill bit.
- Anchor installation carried out by appropriately qualified personal and under the responsibility of the person responsible for technical matters on site
- After installation further turning of the anchor is not possible. The head of the anchor is supported on the fixture and is not damaged.

## Concrete Screw BSZ

Intended use  
Specifications

**Annex B1**

**Table B1: Installation parameters**

Anchor size			BSZ 5	BSZ 6	
Nominal embedment depth	$h_{nom}$	[mm]	35	35	55
Nominal drill bit diameter	$d_0$	[mm]	5	6	
Cutting diameter of drill bit	$d_{cut} \leq$	[mm]	5,4	6,4	
Effective anchorage depth	$h_{ef}$	[mm]	27	27	44
Depth of drill hole	$h_1 \geq$	[mm]	40	40	60
Diameter of clearance hole in the fixture	$d_f \leq$	[mm]	7	8	
Max. Installation torque for screws with metric connection thread	$T_{inst} \leq$	[Nm]	8	10	
Tangential impact screw driver <sup>1)</sup>	$T_{imp,max}$	[Nm]	110	160	

<sup>1)</sup> Installation with tangential impact screw driver, with maximum power output  $T_{imp,max}$  acc. to manufacturers instructions is possible

**Table B2: Minimum thickness of member, minimum edge distance and minimum spacing for anchorages in solid concrete**

Anchor size			BSZ 5	BSZ 6	
Nominal embedment depth	$h_{nom}$	[mm]	35	35	55
Minimum thickness of member	$h_{min}$	[mm]	80	80	100
Minimum edge distance	$c_{min}$	[mm]	35	35	40
Minimum spacing	$s_{min}$	[mm]	35	35	40

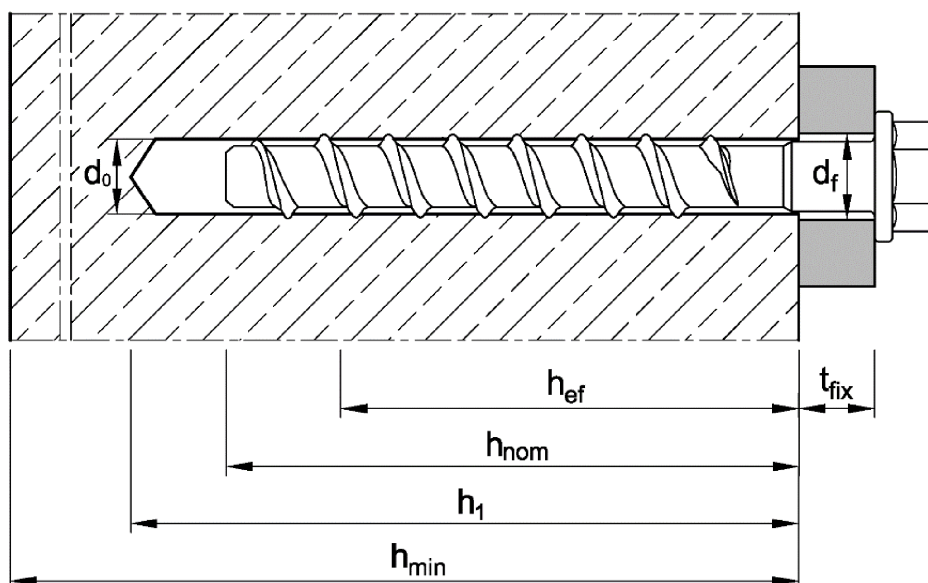

**Concrete Screw BSZ**

**Intended use**

Installation parameters  
Minimum thickness of concrete member, minimum spacing and edge distance (solid concrete)

**Annex B2**

English translation prepared by DIBt

**Table B3: Minimum edge distances and minimum spacing** for anchorages in precast pre-stressed hollow core slabs

Anchor size			BSZ 6		
Flange thickness	$d_b$	[mm]	$\geq 25$	$\geq 30$	$\geq 35$
Minimum edge distance	$c_{min}$	[mm]	$\geq 100$ mm		
Minimum spacing	$s_{min}$	[mm]	$\geq 100$ mm		
Minimum distance between anchor groups	$a_{min}$	[mm]	$\geq 100$ mm		

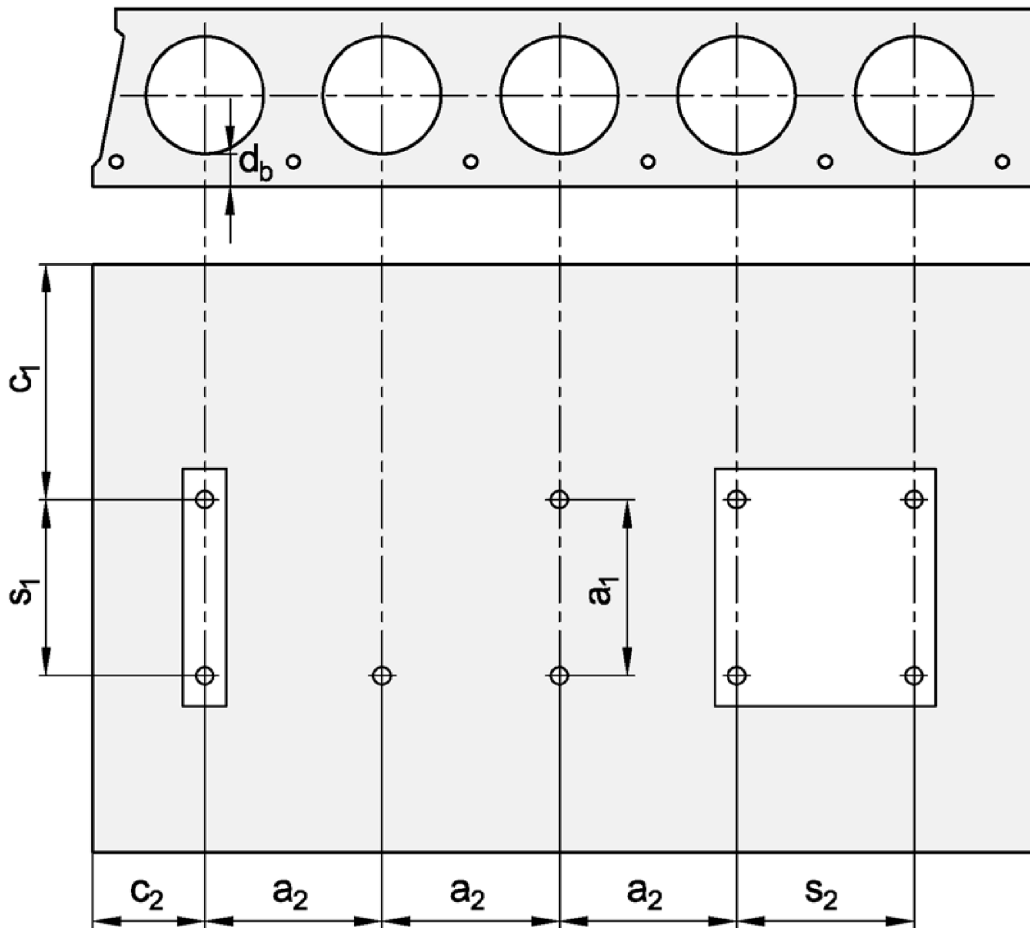

$c_1, c_2$  Edge distance  
 $s_1, s_2$  Spacing  
 $a_1, a_2$  Distance between anchor groups

**Concrete Screw BSZ**

**Intended use**  
Installation parameters (precast pre-stressed hollow core slabs)

**Annex B3**

### Installation instructions for anchorages in solid concrete slabs

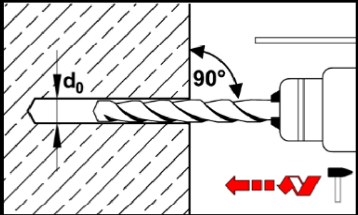
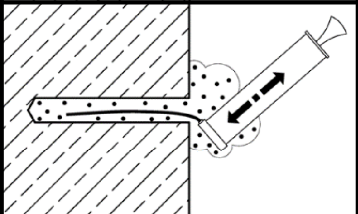
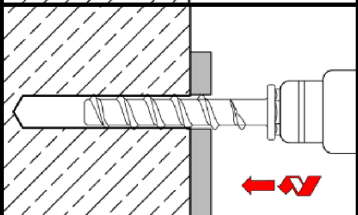
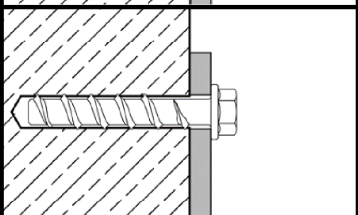
1		<p>Drill hole perpendicular to concrete surface. Using a suction drill, continue with step 3.</p>
2		<p>Blow out dust or alternatively vacuum clean down to the bottom of the hole.</p>
3		<p>Screw in concrete screw, e.g. with tangential impact screw driver or torque wrench.</p>
4		<p>After installation, the head of the anchor is supported on the fixture must be undamaged.</p>

#### Concrete Screw BSZ

**Intended use**  
Installation instructions (solid concrete)

**Annex B4**

**Installation instructions** for anchorages in precast pre-stressed hollow core slabs

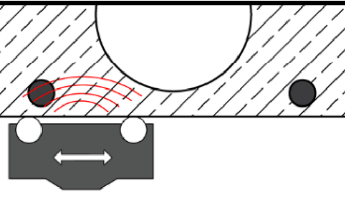
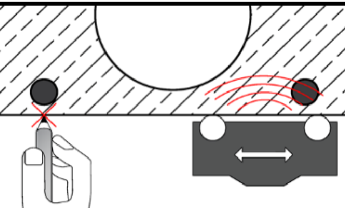
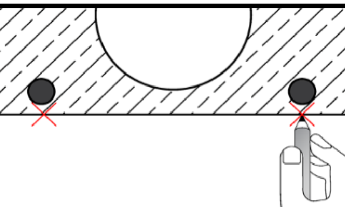
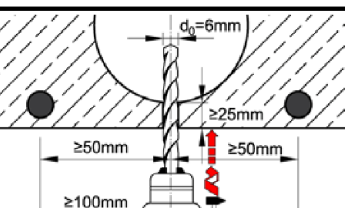
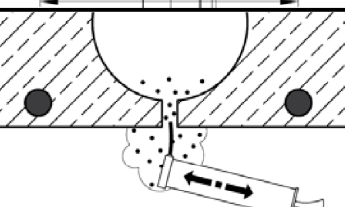
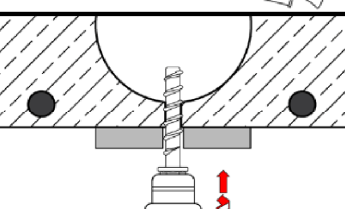
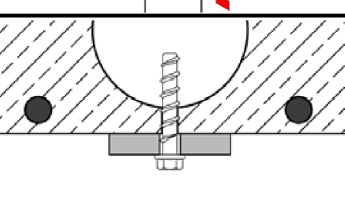
1		Search for position of pre-stressing steel.
2		Mark position and search for the next position of pre-stressed steel.
3		Mark second position of pre-stressed steel.
4		Drill hole taking into account the installation parameters and distances. Using a suction drill, continue with step 6.
5		Blow out dust or alternatively vacuum drill hole.
6		Screw in concrete screw, e.g. with tangential impact screw driver or torque wrench.
7		After installation, the head of the anchor is supported on the fixture and must be undamaged.

**Concrete Screw BSZ**

**Intended use**  
Installation instructions (precast pre-stressed hollow core slabs)

**Annex B5**

**Table C1: Characteristic values for anchorages in solid concrete**

Anchor size			BSZ 5	BSZ 6	
Nominal embedment depth	$h_{nom}$	[mm]	35	35	55
<b>Tension load</b>					
Installation factor	$\gamma_{inst}$	[-]	1,2	1,0	
<b>Steel failure</b>					
Characteristic resistance	$N_{Rk,s}$	[kN]	8,7	14,0	
Partial factor	$\gamma_{Ms,N}$	[-]	1,5	1,5	
<b>Pull-out</b>					
Characteristic resistance in cracked and uncracked concrete C20/25	$N_{Rk,p}$	[kN]	1,5	3,0	7,5
Increasing factor for $N_{Rk,p}$	$\Psi_C$	[-]	$\left(\frac{f_{ck}}{20}\right)^{0,5}$		
<b>Concrete cone failure</b>					
Effective anchorage depth	$h_{ef}$	[mm]	27	27	44
Spacing	$s_{cr,N}$	[mm]	3 $h_{ef}$		
Edge distance	$c_{cr,N}$	[mm]	1,5 $h_{ef}$		
Factor $k_1$ for concrete	cracked	$k_{cr,N}$	7,7		
	uncracked	$k_{ucr,N}$	11,0		
<b>Splitting</b>					
Spacing	$s_{cr,sp}$	[mm]	120	120	160
Edge distance	$c_{cr,sp}$	[mm]	60	60	80
<b>Shear load</b>					
Installation factor	$\gamma_{inst}$	[-]	1,0	1,0	
<b>Steel failure without lever arm</b>					
Characteristic resistance	$V^0_{Rk,s}$	[kN]	4,4	7,0	
Partial factor	$\gamma_{Ms,V}$	[-]	1,25	1,25	
Ductility factor	$k_7$	[-]	0,8	0,8	
<b>Steel failure with lever arm</b>					
Characteristic bending resistance	$M^0_{Rk,s}$	[Nm]	5,3	10,9	
<b>Concrete pry-out failure</b>					
Pry-out factor	$k_8$	[-]	1,0	1,0	
<b>Concrete edge failure</b>					
Effective length of anchor	$l_f = h_{ef}$	[mm]	27	27	44
Outside diameter of anchor	$d_{nom}$	[mm]	5	6	

**Concrete Screw BSZ**

**Performance**  
Characteristic values for **tension and shear loads** (solid concrete)

**Annex C1**

**Table C2:** Characteristic values of resistance in **precast pre-stressed hollow core slabs** C30/37 to C50/60

Anchor size			BSZ 6		
Flange thickness	$d_b$	[mm]	$\geq 25$	$\geq 30$	$\geq 35$
Characteristic resistance for all directions	$F_{Rk}$	[kN]	1	2	3
Characteristic bending resistance	$M_{Rk,s}^0$	[Nm]	10,9		
Edge distance	$c_{cr} = c_{min}$	[mm]	100		
Spacing	$s_{cr} = s_{min}$	[mm]	100		
Partial factor	$\gamma_M$	[-]	1,5		
Installation factor	$\gamma_{inst}$	[-]	1,0		

**Concrete Screw BSZ**

**Performance**

Characteristic values of resistance in **precast pre-stressed hollow core slabs**

**Annex C2**

**Table C3:** Characteristic values of resistance under **fire exposure** for anchorages in solid concrete

Anchor size				BSZ 6			
Material				Steel, zinc plated		Stainless steel A4 / HCR	
Nominal embedment depth		$h_{nom}$	[mm]	35	55	35	55
<b>Steel failure (tension and shear resistance)</b>							
Characteristic resistance	R30	$N_{Rk,s,fi}$ = $V_{Rk,s,fi}$	[kN]			0,9	1,2
	R60			0,8	1,2		
	R90			0,6	1,2		
	R120			0,4	0,8		
<b>Steel failure with lever arm</b>							
Characteristic bending resistance	R30	$M^0_{Rk,s,fi}$	[Nm]			0,7	0,9
	R60			0,6	0,9		
	R90			0,5	0,9		
	R120			0,3	0,6		
Spacing		$s_{cr,fi}$	[mm]	4 $h_{ef}$			
Edge distance		$c_{cr,fi}$	[mm]	2 $h_{ef}$			
The anchorage depth has to be increased for wet concrete by at least 30 mm compared to the given values							

The characteristic resistance for pull-out, concrete cone failure, concrete pry-out and concrete edge failure shall be calculated according to EN 1992-4:2018.

**Concrete Screw BSZ**

**Performance**

Characteristic values of resistance under **fire exposure** (solid concrete)

**Annex C3**