

Masonry Repair Applications, New Build Applications and Technical Information

SURETWIST MATERIAL / TECHNICAL DATA

The SureTwist Helical Anchorage System is offering you an optimum solution. SureTwist is an austenitic stainless steel, Grade 1.4301 or 1.4401 - DIN EN 10088 Part 3 (1995). AISI - 304 or 316, reinforcing material that has many unique properties (Or 8.8 High Tensile Steel for specific applications). Being rolled from a plain round wire, the fins are work-hardened to a very high level whilst the core remains relatively soft. The subsequent twisting process puts the fins into tension and the core into compression. The tension induced by the twisting process also ensures that any impurities in the base material are detected early, helping to produce a safer product. The tensile strength of the base material is more than doubled during the manufacturing process. The pronounced fins over the core make the bonding characteristics of the SureTwist Profile far superior to alternative standard reinforcing materials.

The SureTwist Profile will be available in 3mm, 4,5mm, 6mm, TC7mm, 8mm, TC8mm, TC9mm, 10mm and PZ Steel TC8. Lengths from 100 mm up to 10.000 mm. It is supplied in ten types depending on the application. Bars without points are used in the reinforcement system. Bars with one or two points are used in the anchorage system, along with the two point dual diameter tie. We can supply the material in any length and profile to meet the requirements of structural engineers and other specifiers.

We have introduced the TC (Thick Core) range of sections for use with the fixing and anchorage systems. The TC range has improved performance in shear and compressive loads and helps prevent deflection and bending over a longer fixing distance.

Uses – The uses of the bars are both wide and varied and they can be utilised in new build and for many specialised refurbishment requirements like apartment buildings, historic buildings, bridges and many more (build materials – concrete, brick, stone, wood, autoclave (aircrete) and others). The SureTwist Profile can be used for structural reinforcement or anchorage fixings.



SureTwist Bar



Applications in remedial situations:

- ▢ Unlimited masonry reinforcement and anchorage applications
- ▢ Cracks restoration of any type
- ▢ Subsequent needling of double walled masonry
- ▢ Fixing into all types of stones and materials, including concrete
- ▢ Manufactured from austenitic stainless steel of 3, 4.5, 6, 8, TC8, TC9 and 10mm diameters in any length from 7cm to 10m



SureTwist Plus



SureTwist Extra



SureTwist AS Dual Diameter



Applications in remedial situations:

- ▢ Unlimited masonry reinforcement and anchorage by manual hammering
- ▢ Subsequent needling of double walled masonry by manual hammering
- ▢ Driving with a hammer into all types of stone, including concrete, to stabilize and fasten, by pilot-drilling with a reduced diameter
- ▢ Driving with a hammer directly into soft structures for stabilizing and fastening, also into wood and synthetic material
- ▢ Manufactured from austenitic stainless steel of 4.5, 6, TC7, 8, TC8, TC9 and 10 mm diameters in any length from 5 cm to 1m
- ▢ SureTwist Plus is supplied with one point
- ▢ SureTwist Extra is supplied with two points
- ▢ SureTwist AS is supplied with two points

CONSTRUCTION PRODUCTS SOLUTIONS INTERNATIONAL LTD.

Unit 3, Haslemere Industrial Estate, Pig Lane, Bishop's Stortford, Hertfordshire. CM23 3HG. United Kingdom.
Tel: +44(0)1279 505 514 - Fax: +44(0)1279 755190 - e mail: info@surecps-group.com - www.surecps-group.com
Company Reg. 6969591 VAT Reg. GB 824 4246 40





SureTwist



SureTwist Plus



SureTwist Extra



PZ Steel TC8

Applications in new build situations:

- ▣ As masonry reinforcement.
- ▣ As a wall connector.
- ▣ As a cavity wall anchor with and without insulation.
- ▣ Fixing into all types of stone, including concrete.
- ▣ Driving with a hammer into all types of stone, including concrete, to stabilize and fasten by pilot-drilling with a reduced diameter.
- ▣ Driving with a hammer directly into soft structures for stabilizing and fastening, also into wood and synthetic material.
- ▣ Manufactured from austenitic stainless steel of 4.5, 6, TC7, 8, TC8, TC9, and 10 mm diameters in any length from 5 cm to 1 m.
- ▣ SureTwist Plus is supplied with one point.
- ▣ SureTwist Extra is supplied with two points.
- ▣ PZ Steel TC8 is manufactured from 8.8 high tensile steel, zinc plated and passivated. 8mm diameter in lengths from 75mm to 220mm
- ▣ PZ Steel TC8 is supplied with one point, and with either a 20mm head or shoulder to accept the power installation tool.



LOK 1118/A/08 ITB KATOWICE
DIN EN ISO 6892-1:2001, EN 845-1:2003, EN 845-1:213, EN 846-5:2000 EN 846-5:2012 and EN 846-7:2000

SUREGROUT AND SUREBOND APPLICATION QUANTITIES

SureBond Polyester Resin

Product	380/ 400 ml Cartridge
SureTwist Bar	1.2 linear metre
SureTwist Resin to Resin remedial wall tie 10mm dia hole	15



PZ1.1/07-095
DIN EN 998-2:2004

SureGrout

Product	6 litre	3 litre	1.5 litre
SureTwist Grout Tie [14mm clearance hole]	32	16	8
SureTwist Grout Tie [16mm clearance hole]	20	10	5
SureTwist Grout Tie [18mm clearance hole]	14	7	3.5
6mm SureTwist Bar [Crack Stitching 10 x 35mm slot]	16	8	5
6mm SureTwist Bar [SureBeam Twin Rod 10 x 55mm slot]	12	6	3

(Quantities are per linear metre)

CONSTRUCTION PRODUCTS SOLUTIONS INTERNATIONAL LTD.

Unit 3, Haslemere Industrial Estate, Pig Lane, Bishop's Stortford, Hertfordshire. CM23 3HG. United Kingdom.
Tel: +44(0)1279 505 514 - Fax: +44(0)1279 755190 - e mail: info@surecps-group.com - www.surecps-group.com
Company Reg. 6969591 VAT Reg. GB 824 4246 40



SUREGROUT

SureGrout is a two component, non shrink cementitious based thixotropic mortar. It is specifically developed to work with SureTwist bars to complete a system of masonry repairs.



SureGrout SG 60

with a strength of 60.0 Mpa for harder masonry



SureGrout S

with a strength of 27.5 Mpa for normal masonry



SureGrout HS

with a strength of 38 Mpa especially for concrete masonry



SureGrout SR

Sulphite resistant: with a strength of 33 Mpa especially for aggressive environments, such as coastal regions or chemical industries

SUREBOND



TE Injection Resin

We recommend the use of the SureBond TE resin for sealing cracks after Crack-stitching or Beaming has been completed.

SureBond TE Resin is a non-shrink Thixotropic epoxy resin that will fill cracks from .5mm to 20mm wide. For sealing and bonding the cracks.

SureBond Polyester resin 400ml

CONSTRUCTION PRODUCTS SOLUTIONS INTERNATIONAL LTD.

Unit 3, Haslemere Industrial Estate, Pig Lane, Bishop's Stortford, Hertfordshire. CM23 3HG. United Kingdom.
Tel: +44(0)1279 505 514 - Fax: +44(0)1279 755190 - e mail: info@surecps-group.com - www.surecps-group.com
Company Reg. 6969591 VAT Reg. GB 824 4246 40



BASIC HELICAL LOAD TEST UNIT 1



With this pull test device the actual pulling forces of the inserted SureTwist product can be measured to satisfy the requirements of customers and specifiers.

The measuring spectrum ranges from 0 to 4 kN



LTU – Preparation



LTU – Preparation



LTU – Preparation



Attaching



Measuring

MULTI - PURPOSE LOAD TEST UNIT 2



Model CPSI2000

- Unique to CPSI, this tension tester, has been manufactured for the specific purpose of testing all CPSI products up to tensile loads of 25 kN.
- Each tester can be supplied with specific adaptors to suit each CPSI product range including Suretwist helical products.
- The CPSI tension tester is fully adjustable without the need to use any additional items for support of the test equipment in order to carry out a pullout test successfully.
- All CPSI tension testers are calibrated before they leave the factory (this can be done each subsequent year on request), ensuring that all tests are carried out to the highest degree of accuracy and thus meeting your quality standards.
- Testers are supplied in a Reinforced Plastic case which can withstand the toughest site conditions.

CONSTRUCTION PRODUCTS SOLUTIONS INTERNATIONAL LTD.

Unit 3, Haslemere Industrial Estate, Pig Lane, Bishop's Stortford, Hertfordshire. CM23 3HG. United Kingdom.
Tel: +44(0)1279 505 514 - Fax: +44(0)1279 755190 - e mail: info@surecps-group.com - www.surecps-group.com
Company Reg. 6969591 VAT Reg. GB 824 4246 40



TECHNICAL DATA / SURETWIST PROFILE

Product	Profile	Helical Pitch	KG / mm	KG / 10m
SureTwist Bar	6	25	0.000067	0.669
SureTwist Bar	8	30	0.000079	0.786
SureTwist Bar	10	50	0.000111	1.114
SureTwist Plus	6	30	0.000069	0.691
SureTwist Plus	8	40	0.000073	0.732
SureTwist Plus	10	50	0.000102	1.020
SureTwist Extra	6	30	0.000064	0.636
SureTwist Extra	8	40	0.000077	0.765
SureTwist Extra	10	50	0.000108	1.085

Profile	Area	Tensile Strength		Yield Point	Elongation	E - Modul
	mm ²	N/mm ²	KN	N/mm ²	% (A 100mm)	G Pa
6	8	900	7.2	745	5.1	156.269
8	10	880	8.8	745	4.7	148.813
10	13	823	10.7	640	4.2	146.114

Profile mm	Number of bars / Area A (mm ²)				
	1	2	3	4	5
6	8	16	24	32	40
8	10	20	30	40	50
10	13	26	39	52	65

Designation	BS 5628 Part 2 : 1995	
	Profile	Char. Tensile Strength
TYPES 304Cu a 316L STAINLESS STEEL BS 6744	All	460 MPa

Stainless Steel Designation Norm Standard European and USA

STANDARDS	EU DESIGNATION	USA DESIGNATION AISI / UNS
EN 10088-1		
X3CrNi 18-9-4	1.4567	304 Cu / S20430
X2CrNiMo 17-12-2	1.4404	316 L/S31603

AISI – American Iron Steel Institute, UNS – Unified Numbering System

Table – Class of Corrosion (Resistance) and of Strength

DIBT Berlin – Deutches Institut für Bautechnik (+ Cold Reduced Steel Wire)

STEEL	CLASS OF CORROSION RESISTANCE	CLASS OF CORROSION ACCORDANT WITH YIELD POINT R _{po,2}	
		S 235	S 275
Cr-Ni-Cu	II	1.4567	1.4567
Cr-Ni-Mo	III	1.4404	1.4404

CONSTRUCTION PRODUCTS SOLUTIONS INTERNATIONAL LTD.

Unit 3, Haslemere Industrial Estate, Pig Lane, Bishop's Stortford, Hertfordshire. CM23 3HG. United Kingdom.
Tel: +44(0)1279 505 514 - Fax: +44(0)1279 755190 - e mail: info@surecps-group.com - www.surecps-group.com
Company Reg. 6969591 VAT Reg. GB 824 4246 40



TECHNICAL DATA / SURETWIST – TENSILE STRENGTH

Concrete 15 (Samples 150 x 150mm) - Pull Out (SureGrout HS)

Profile	Drill Hole Ø	Embedment	Tensile Strength	Shear Area	R _t
	mm	mm	KN	mm ²	N/mm ²
8	25.13	150	3.820	3769.5	1.010
10	31.42	150	3.833	4713.0	0.813

Air Concrete 15 (Samples 150 x 150mm) - Pull Out (SureGrout S)

Profile	Drill Hole Ø	Embedment	Tensile Strength	Shear Area	R _t
	mm	mm	KN	mm ²	N/mm ²
8	25.13	150	2.610	3769.5	0.693
10	31.42	150	2.470	4713.0	0.530

Brick (3 layers) - Pull Out (SureGrout S)

Profile	Drill Hole Ø	Embedment	Tensile Strength	Shear Area	R _t
	mm	mm	KN	mm ²	N/mm ²
8	25.13	210	5.680	3769.5	1.080
10	31.42	210	3.330	4713.0	0.510

Pull Out – SureTwist Plus / Extra – Wood (Pine) Perpendicular

Profile	Profile Circuit Ø	Embedment	Tensile Strength	Shear Area	R _t
	mm	mm	KN	mm ²	N/mm ²
6	18.85	150	2.700	2827.2	0.955
8	25.13	150	2.940	3769.5	0.781
10	31.42	150	3.230	4713.0	0.685

Pull Out – SureTwist Plus / Extra – Wood (Pine) Parallel

Profile	Profile Circuit Ø	Embedment	Tensile Strength	Shear Area	R _t
	mm	mm	KN	mm ²	N/mm ²
6	18.85	150	2.430	2827.2	0.858
8	25.13	150	2.230	3769.5	0.591
10	31.42	150	2.640	4713.0	0.560

Limestone - Pull Out (SureGrout HS)

Profile	Drill Hole Ø	Embedment	Tensile Strength	Shear Area	R _t
	mm	mm	KN	mm ²	N/mm ²
8	14	100	6.105	4398	1.388
8	14	200	8.800*	8796	1.000
8	14	300	8.800*	13194	0.667

*) Tensile Strength – Suretwist 8mm

Lime sandstone - Pull Out (SureGrout HS)

Profile	Drill Hole Ø	Embedment	Tensile Strength	Shear Area	R _t
	mm	mm	KN	mm ²	N/mm ²
8	14	100	3.180	4398	0.723
8	14	200	7.910	8796	0.899
8	14	300	8.570	13194	0.650

Data exemplary! Please ask our factory for more technical data. Please ask our technical support team for static calculations.

CONSTRUCTION PRODUCTS SOLUTIONS INTERNATIONAL LTD.

Unit 3, Haslemere Industrial Estate, Pig Lane, Bishop's Stortford, Hertfordshire. CM23 3HG. United Kingdom.
Tel: +44(0)1279 505 514 - Fax: +44(0)1279 755190 - e mail: info@surecps-group.com - www.surecps-group.com
Company Reg. 6969591 VAT Reg. GB 824 4246 40



Please always wear the appropriate safety and protective clothing when installing fixing and anchor products. Always observe the necessary Health & Safety guidelines.

© All text copyright. Above information is given as guidance only and should always be verified by a suitable engineer.

The above information is given in good faith, and may be subject to alteration at any time without prior notification.

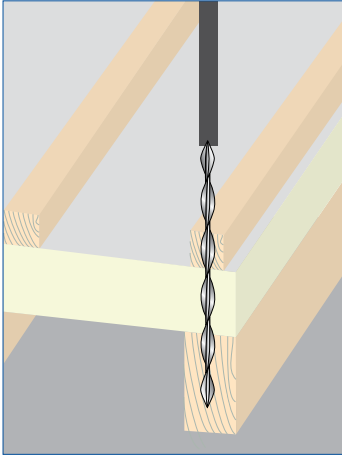

General Applications:

- ▢ Masonry repairs
- ▢ Arch construction
- ▢ Cavity walls
- ▢ Roof fixings
- ▢ Highway bridges
- ▢ Historic bridges
- ▢ Historic buildings
- ▢ Modular circuit board designs
- ▢ Retaining dams
- ▢ New Build wall ties
- ▢ Starter Ties to existing masonry
- ▢ Timber to masonry fixing

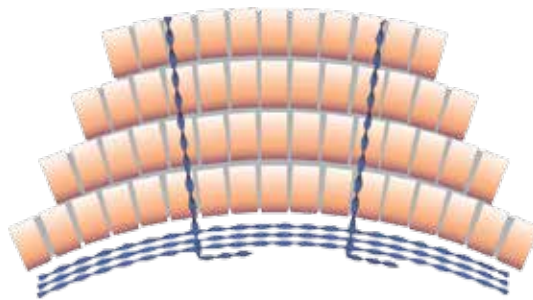
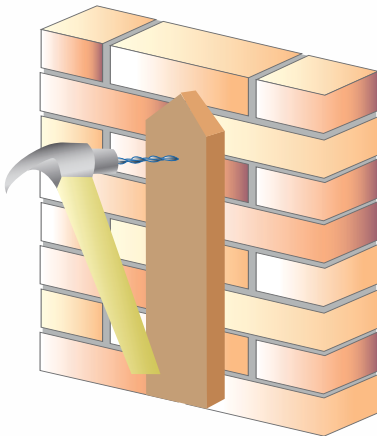
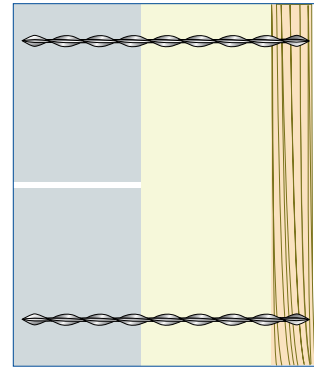
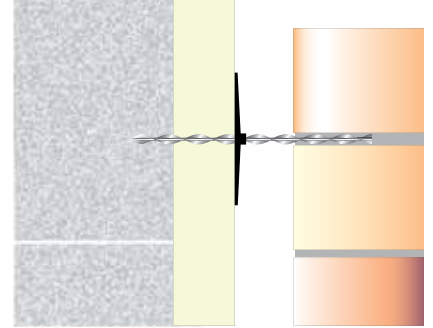

Material Benefits:

- ▢ No load and tension concentration
- ▢ Load dispensed over the complete length of the bar
- ▢ No additional plates or screws
- ▢ No additional fixings
- ▢ Ideal interaction with the masonry

CONSTRUCTION PRODUCTS SOLUTIONS INTERNATIONAL LTD.

Unit 3, Haslemere Industrial Estate, Pig Lane, Bishop's Stortford, Hertfordshire. CM23 3HG. United Kingdom.
 Tel: +44(0)1279 505 514 - Fax: +44(0)1279 755190 - e mail: info@surecps-group.com - www.surecps-group.com
 Company Reg. 6969591 VAT Reg. GB 824 4246 40



CAUSES / ORIGIN OF CRACKING



Causes – Crack origin:

- ▢ Temperature influence
- ▢ Damage due to damp
- ▢ Wind loads
- ▢ Fractured masonry
- ▢ Lack of foundation
- ▢ Cracks due to freeze/thaw activity
- ▢ Lowering of ground water
- ▢ Imbalanced building grounds
- ▢ Road traffic vibration
- ▢ Air traffic
- ▢ Damaged drains
- ▢ Proximity of trees to the building

The nature and causes of cracking can be due to not only one factor, but a number of factors working together that lead to subsidence, bowed walls, delaminated bricks and general deterioration of the masonry structure. As you see our SureTwist range offers a solution to most of these specific problems. From the SureBeam masonry reinforcement system to remedial wall ties.

All of the products are free of expansion stresses when they are installed, so no further stresses will be introduced into the structure, and because they are easy and fast to install, the integrity and stability of the structure is restored quickly and economically.

In most situations the products are installed externally causing the minimum amount of disruption to both the structure and the occupants.

We would always recommend that a full survey is carried out by a qualified Structural Engineer before any work commences.



CONSTRUCTION PRODUCTS SOLUTIONS INTERNATIONAL LTD.

Unit 3, Haslemere Industrial Estate, Pig Lane, Bishop's Stortford, Hertfordshire. CM23 3HG. United Kingdom.
Tel: +44(0)1279 505 514 - Fax: +44(0)1279 755190 - e mail: info@surecps-group.com - www.surecps-group.com
Company Reg. 6969591 VAT Reg. GB 824 4246 40



SURETWIST MASONRY REPAIR SYSTEMS

Beaming

Used when masonry has lost its load bearing capabilities. SureBeam system gives horizontal mortar bed reinforcement, that ties the masonry together, forming deep masonry beams which distributes the building loads. Helping to stabilise and reintroduce the integrity of the structure.

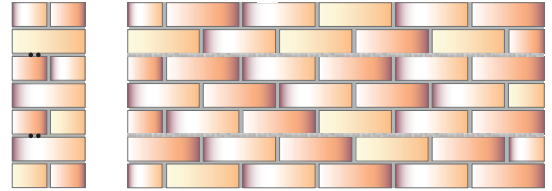

Materials: SureTwist Bar, SureGrout, SureBond TE resin and SureBond, SureStain (Colour Match Mortar).

Crack-stitching

For Reconnecting cracked masonry and reinforcement of bed joint masonry.

Materials: SureTwist Bar, SureGrout, SureBond TE resin and SureBond, SureStain (Colour Match Mortar).

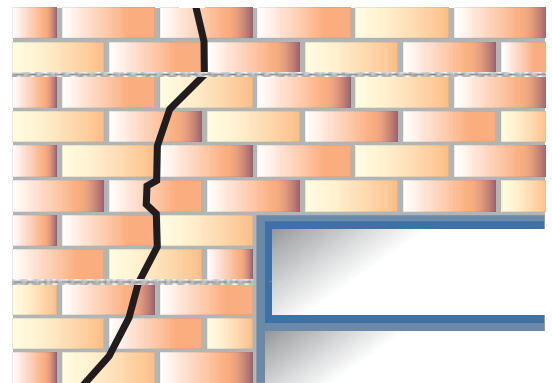

Grout ties

Stabilising solid and rubble filled walls, repair of delaminated brick, securing failed brick lintels, Tying internal walls to external walls and connecting internal party walls to external walls.

Material: SureTwist Bar, SureGrout, SureBond TE resin and SureBond, SureStain (Colour Match Mortar).

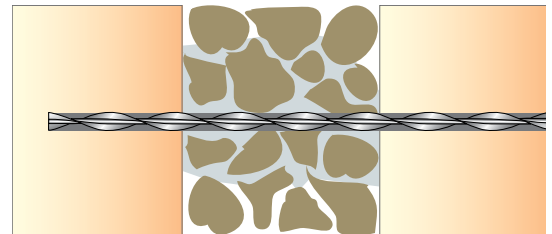

Lateral restraint ties

Stabilising bowed walls.

Materials: Heavy Weight Lateral Restraint Tie. (Side Joist) SE Lateral Restraint Tie. (End Joist) and SureBond Polyester Resin, SureBond TE resin and SureBond, SureStain (Colour Match Mortar).

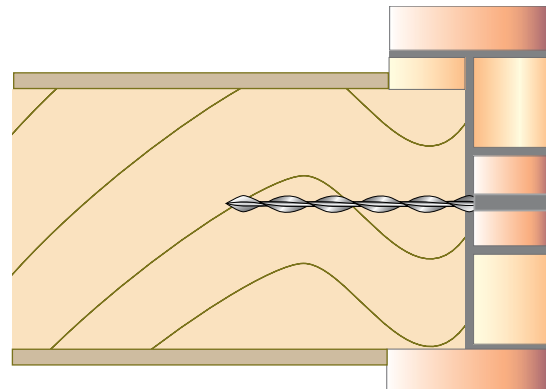

CONSTRUCTION PRODUCTS SOLUTIONS INTERNATIONAL LTD.

Unit 3, Haslemere Industrial Estate, Pig Lane, Bishop's Stortford, Hertfordshire. CM23 3HG. United Kingdom.
Tel: +44(0)1279 505 514 - Fax: +44(0)1279 755190 - e mail: info@surecps-group.com - www.surecps-group.com
Company Reg. 6969591 VAT Reg. GB 824 4246 40



SURETWIST MASONRY REPAIR SYSTEMS cont.

Mechanical wall ties

Used when the existing ties have either corroded or insufficient ties have been used. Tying both the inner (load bearing) leaf with the external wall and pinning together delaminated masonry.

Materials: SureTwist Extra and SureBond, SureStain (Colour Match Mortar).

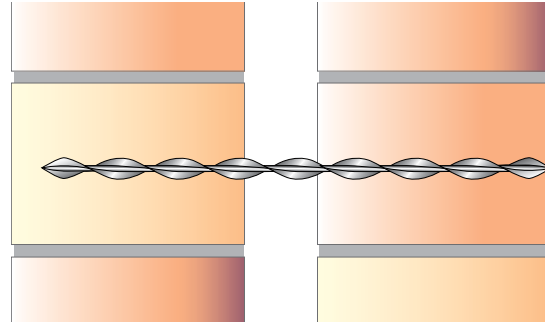

Resin to resin wall ties

Used when the existing ties have either corroded or insufficient ties have been used. Tying both the inner (load bearing) leaf with the external wall.

Materials: SureTwist Plus and SureBond Polyester Resin and SureBond, SureStain (Colour Match Mortar).

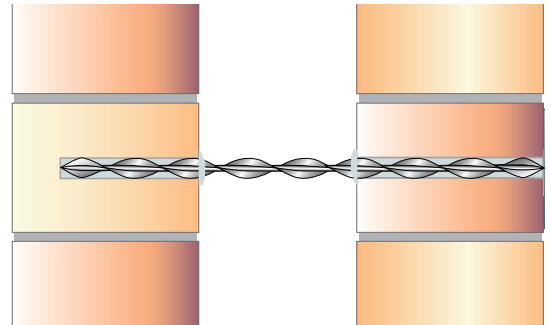

Asymmetrical tie

Re-Tying a soft external substrate to a harder internal wall. The segment of the tie used to attach into the inner leaf has a smaller diameter than that of segment attached in the external wall.

Materials: SureTwist Extra AS and SureBond, SureStain (Colour Match Mortar).

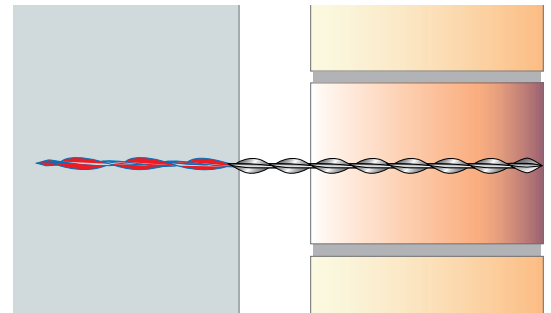

SurePile – Micropile System

A flexible, efficient and environmentally friendly piling system, used to either replace or provide support for an existing structures foundations without the need to use concrete and reinforcement as part of the pile. Suitable for both new and old structures.

Materials. SurePile Aluminium Pile Sections.

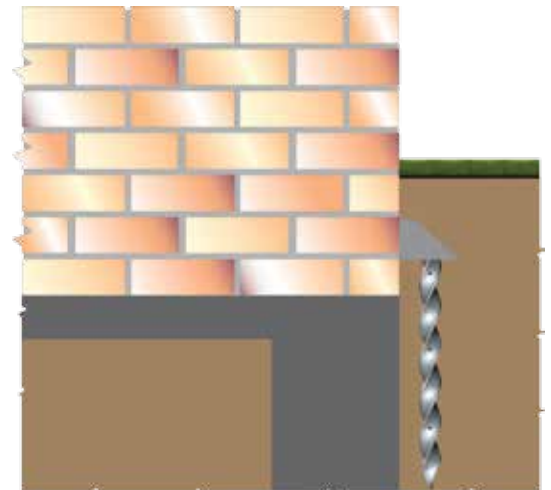

CONSTRUCTION PRODUCTS SOLUTIONS INTERNATIONAL LTD.

Unit 3, Haslemere Industrial Estate, Pig Lane, Bishop's Stortford, Hertfordshire. CM23 3HG. United Kingdom.
Tel: +44(0)1279 505 514 - Fax: +44(0)1279 755190 - e mail: info@surecps-group.com - www.surecps-group.com
Company Reg. 6969591 VAT Reg. GB 824 4246 40



Reconnecting party walls
(see grout tie leaflet)

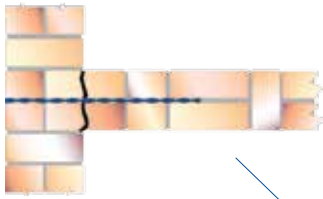

Repairing separated masonry (see
mechanical wall ties or grout tie leaflet)



Stabalising bowed walls into
joist ends (see lateral restraint
tie leaflet)

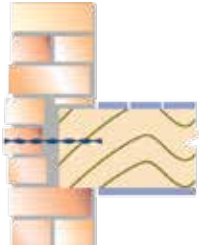

Reconnecting internal to external walls
(see crack-stitching leaflet)

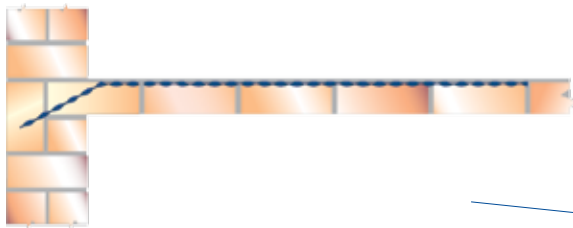

Repairing brick arch lintels
(see SureBeam leaflet)

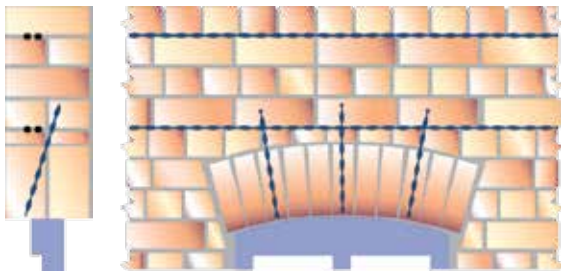

Piling (see SurePile leaflet)

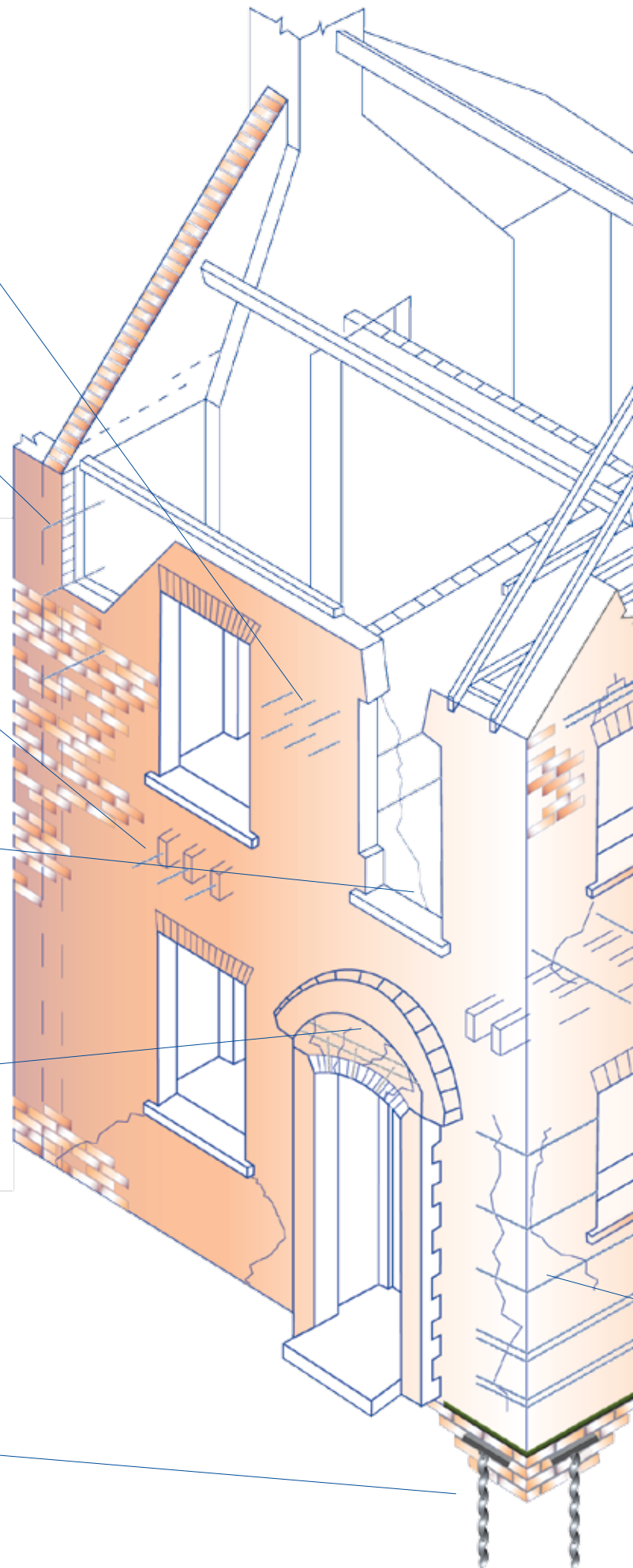
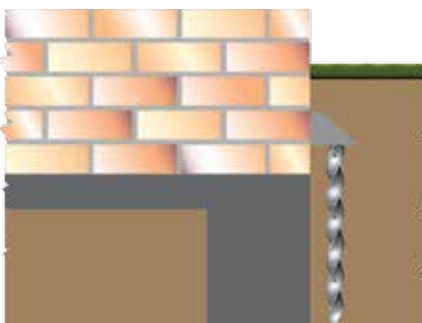

Repairing failed lintels
(see SureBeam leaflet)

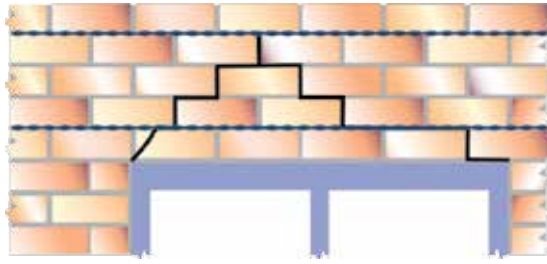

Stabalising bowed walls into side joists
(see heavy weight lateral restraint tie leaflet)

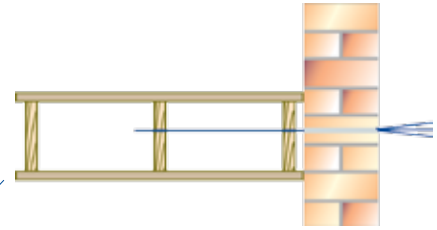

Replacing cavity wall ties
(see mechanical wall ties or resin to resin wall ties)



Stabalising rubble walls
(see grout tie leaflet)



Crack-stitching (see crack stitching leaflet)

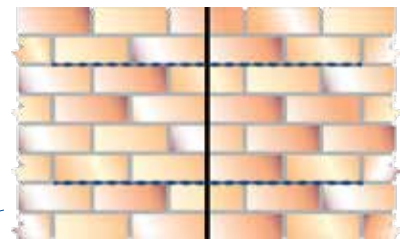

Creating masonry beams
(see SureBeam leaflet)



Repairing cracks near corners and openings
(see crack-stitching leaflet)

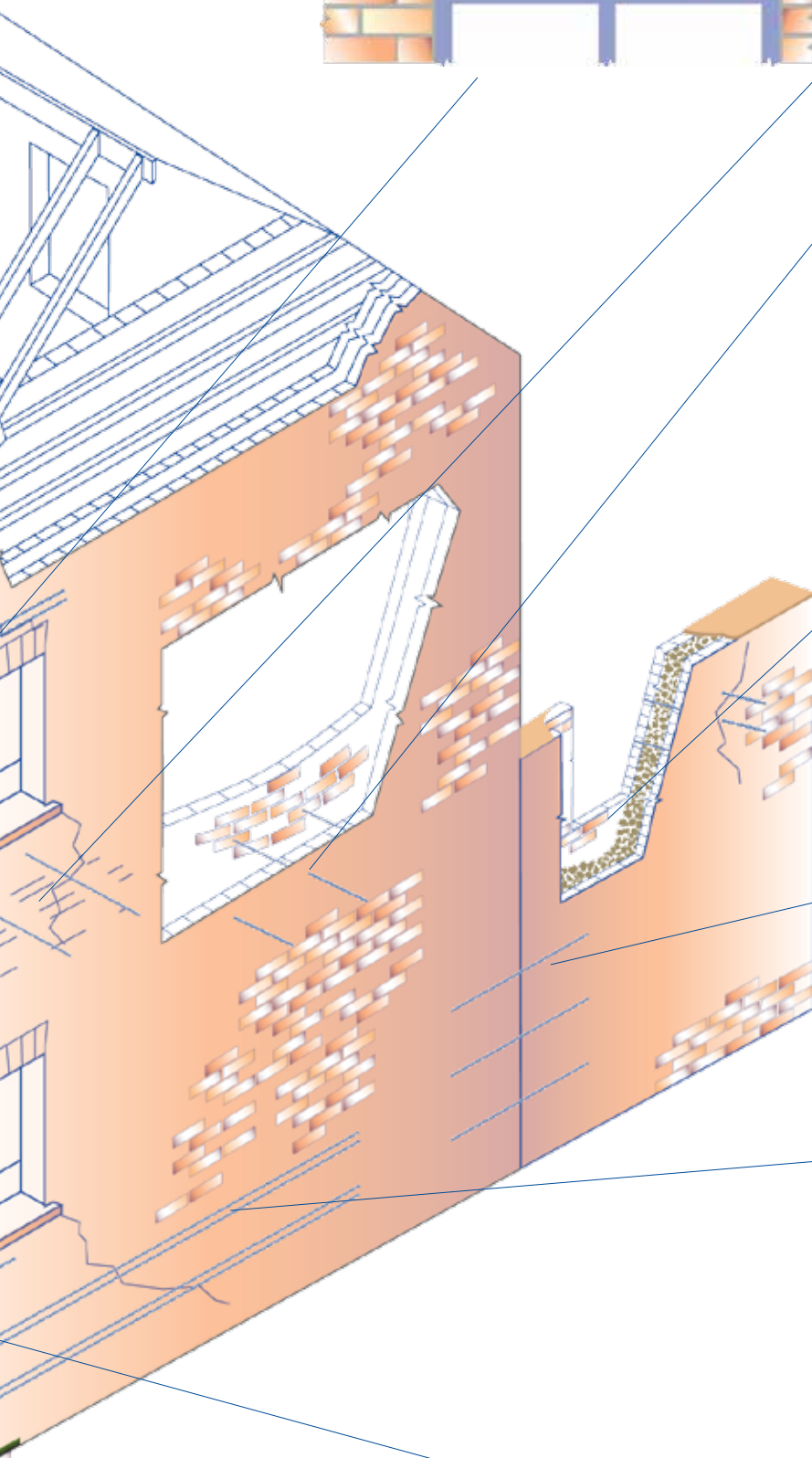
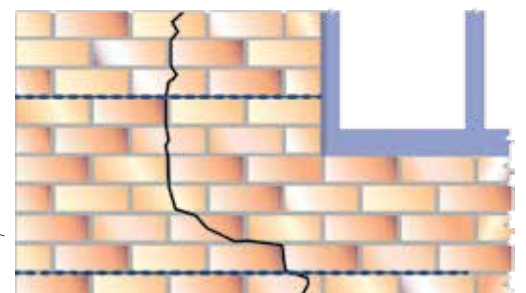

COMPLEMENTARY PRODUCTS

SureKontrakt Ties – Grade A2 Stainless Steel body, 5mm Dia.
with a 10mm copper alloy shells in accordance with BS 1243.

The SureKontrakt Ties are a general purpose remedial wall tie. The SureKontrakt MM is suitable for use in brick, concrete and dense blockwork. The SureKontrakt RM has a unique end to enhance the resin bond, making it suitable for use in fragile and soft inner leaves.

SureKontrakt MM

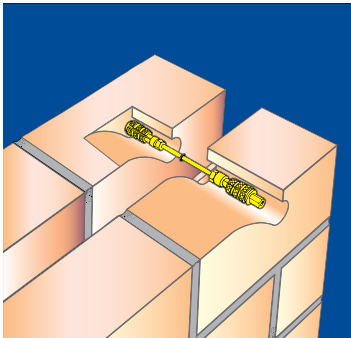

SureKontrakt RM

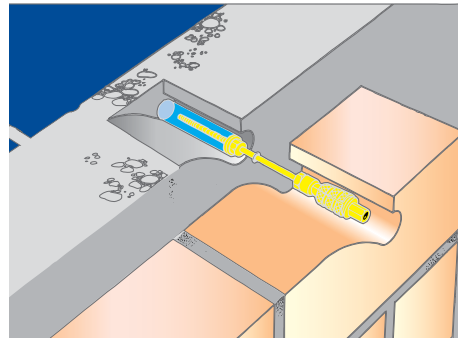

Installation tool

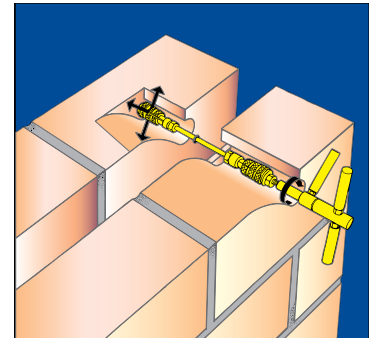

SureKontrakt Range – 5mm x 170mm – 5mm x 195mm – 5mm x 220mm – 5mm x 250mm

Spacing Guide

Least leaf thickness (one or both) mm	Type of Kontrakt Tie	Cavity width mm	Equivalent number of ties /M ²	Spacing of Kontrakt ties	
				Horizontal mm	Vertical mm
65 to 90	All	50 - 100	4.9	450	450

Selection Chart

Least leaf thickness (one or both) mm	Cavity width mm	Tie length mm	Type of tie
90	0 – 15	170	Kontrakt tie
90	15 – 30	195	Kontrakt tie
90	30 – 65	195	Kontrakt tie
90	50 – 90	220	Kontrakt tie
90	80 – 100	250	Kontrakt tie

SURELINO INSULATION FIXINGS

The SureLino insulation fixing is a simple way of securing insulation to various materials.

Please see leaflet for appropriate size, type of screw and installation instructions.

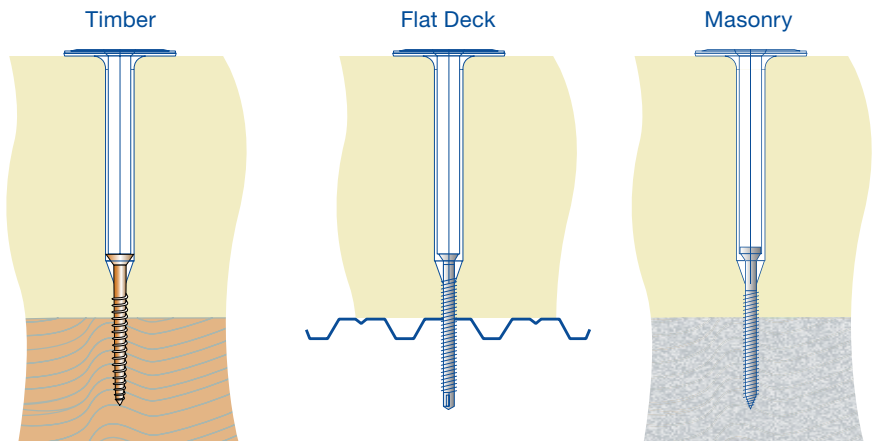

CONSTRUCTION PRODUCTS SOLUTIONS INTERNATIONAL LTD.

Unit 3, Haslemere Industrial Estate, Pig Lane, Bishop's Stortford, Hertfordshire. CM23 3HG. United Kingdom.
Tel: +44(0)1279 505 514 - Fax: +44(0)1279 755190 - e mail: info@surecps-group.com - www.surecps-group.com
Company Reg. 6969591 VAT Reg. GB 824 4246 40



COMPLEMENTARY PRODUCTS

SureClip

The SureClip allows you to retain the SureTwist Bar simply, while the bead of SureGrout is applied.

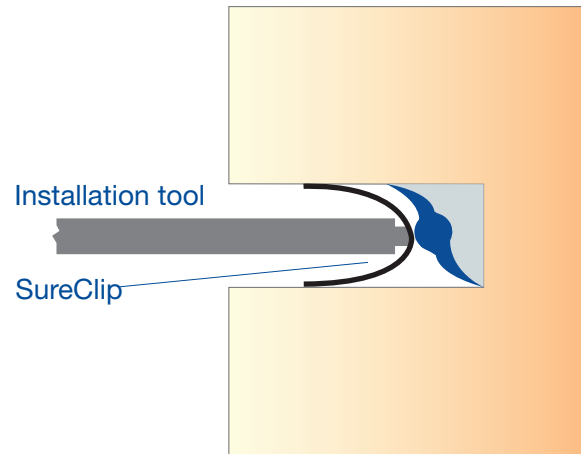
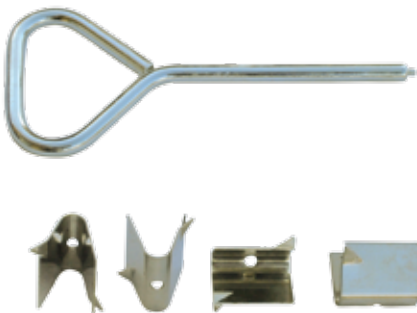

SureBond SureTech Injection Cream

The SureTech cream is an advanced silicone cream for the control of rising damp, Used by injection into the mortar joints of masonry walls. SureTech can be used in all types of masonry without the use of high pressure equipment.

See separate leaflet for technical details.



SureBond SureStain

SureStain colour match mortar is a simple and reliable method of concealing holes or cracks in existing bricks.

SureStain comes in 8 coloured 0.5 litre containers, you simply blend the cementitious powders to match the existing brick colour, then mix with water and apply. Ideal for covering the drilled holes of remedial wall ties, or covering up cracks, once the crack-stitching repair has been carried out.



CONSTRUCTION PRODUCTS SOLUTIONS INTERNATIONAL LTD.

Unit 3, Haslemere Industrial Estate, Pig Lane, Bishop's Stortford, Hertfordshire. CM23 3HG. United Kingdom.
 Tel: +44(0)1279 505 514 - Fax: +44(0)1279 755190 - e mail: info@surecps-group.com - www.surecps-group.com
 Company Reg. 6969591 VAT Reg. GB 824 4246 40



SURETWIST NEW BUILD SYSTEMS

Thin joint wall ties

New build cavity wall tie ideal for aircrete blockwork and applications where there is non alignment of brick and block and tying existing masonry to new.

Materials: SureTwist Plus

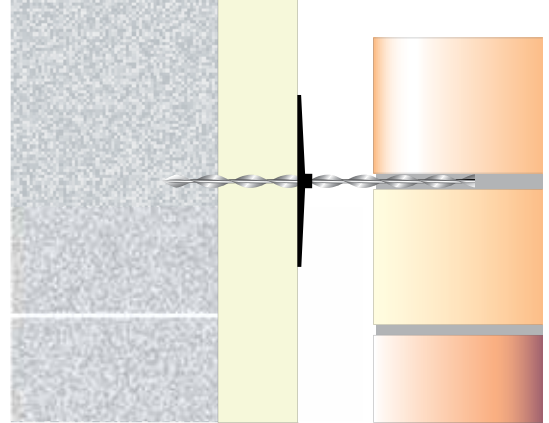

Timber frame wall ties

Tying the brick external cladding to the timber frame.

Materials: SureTwist Plus

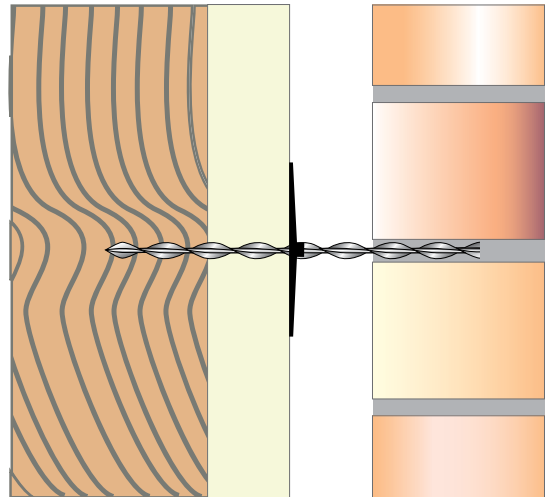

Multi-purpose fixing

For securing MDF and timber to all masonry

Materials: SureTwist Plus and SureTwist PZ Steel TC8

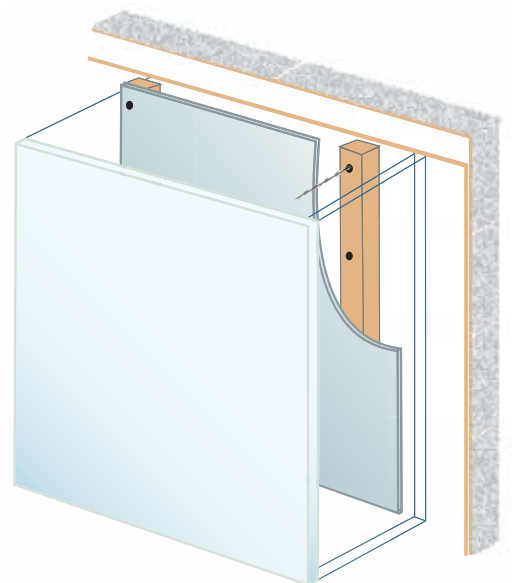

CONSTRUCTION PRODUCTS SOLUTIONS INTERNATIONAL LTD.

Unit 3, Haslemere Industrial Estate, Pig Lane, Bishop's Stortford, Hertfordshire. CM23 3HG. United Kingdom.
Tel: +44(0)1279 505 514 - Fax: +44(0)1279 755190 - e mail: info@surecps-group.com - www.surecps-group.com
Company Reg. 6969591 VAT Reg. GB 824 4246 40



SURETWIST NEW BUILD SYSTEMS cont.

AirTwist

Securing MDF and timber to masonry using a specially designed installation tool for with any SDS hammer drill.

Materials: SureTwist PZ Steel TC8

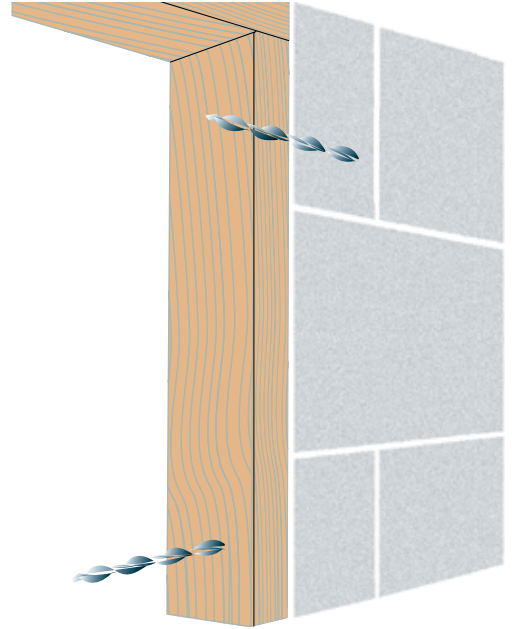

BigTwist

Securing structural 6mm plywood insulation boards onto flat roofs.

Materials: SureTwist PZ Steel TC8

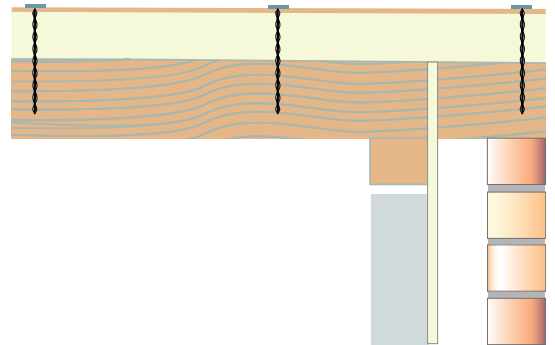

Warm roof fixings

Securing counter battens over a layer of insulation, into the structural roofing timbers.

Materials: SureTwist Plus

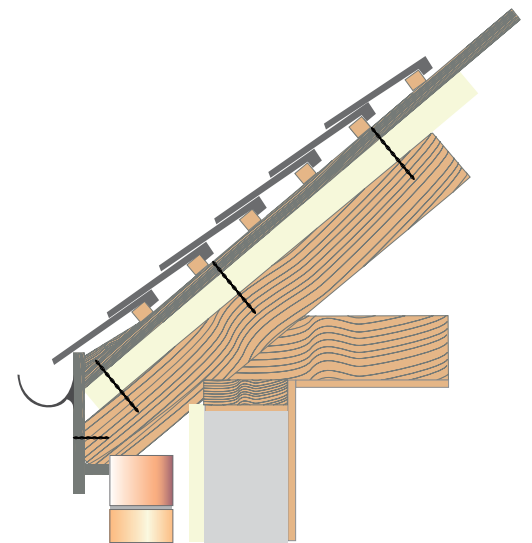

CONSTRUCTION PRODUCTS SOLUTIONS INTERNATIONAL LTD.

Unit 3, Haslemere Industrial Estate, Pig Lane, Bishop's Stortford, Hertfordshire. CM23 3HG. United Kingdom.
Tel: +44(0)1279 505 514 - Fax: +44(0)1279 755190 - e mail: info@surecps-group.com - www.surecps-group.com
Company Reg. 6969591 VAT Reg. GB 824 4246 40



See multi-purpose fixing and airtwist fixing leaflet for details

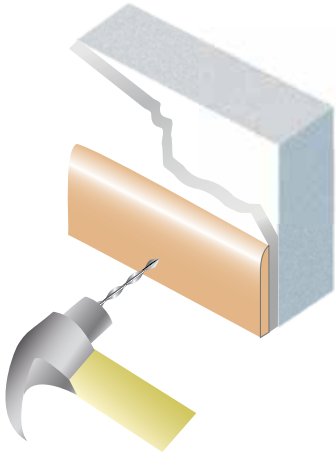

Wall plate detail. Multi-purpose Fixing.

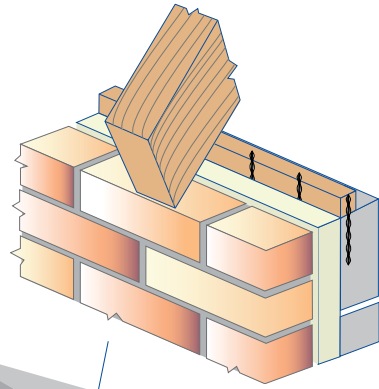

See thin joint fixing leaflet for details

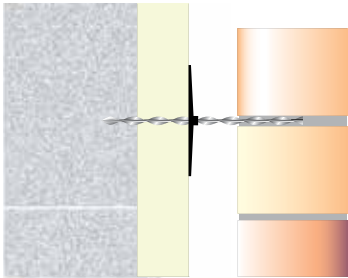

See multi-purpose fixing and airtwist fixing leaflet for details

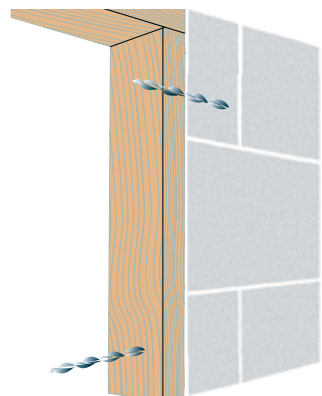
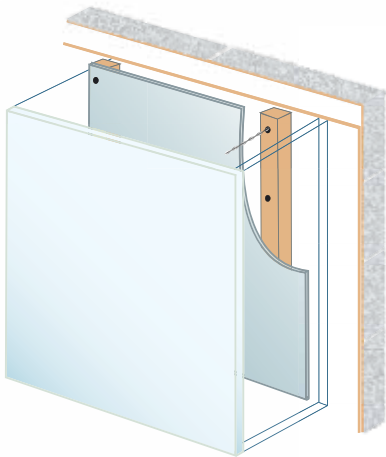

See multi-purpose fixing and airtwist fixing leaflet for details

See warm roof fixing leaflet for details

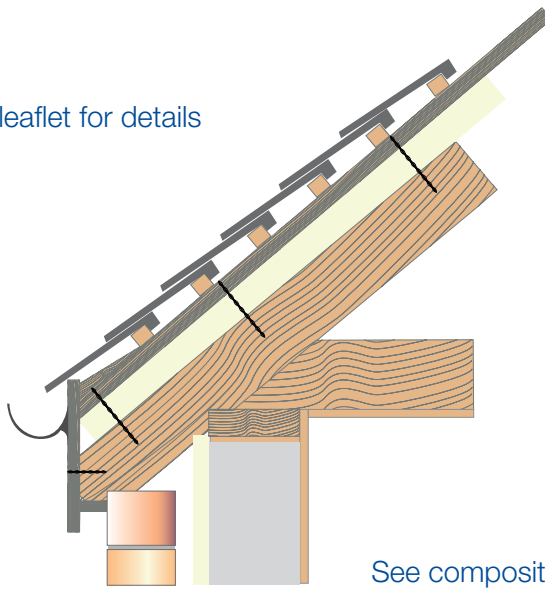

See composite panel fixing leaflet for details

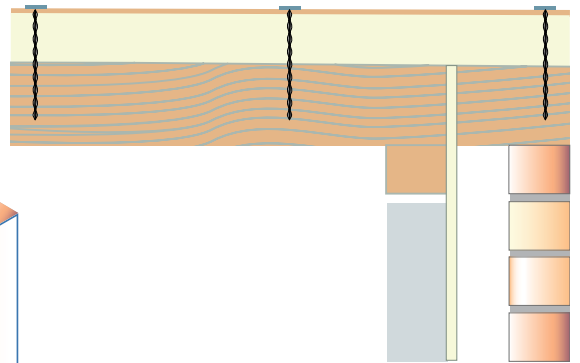

See multi-purpose fixing leaflet for details

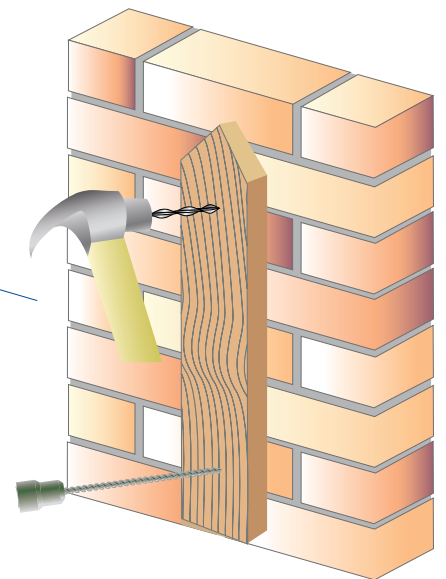

See timber wall ties leaflet for details

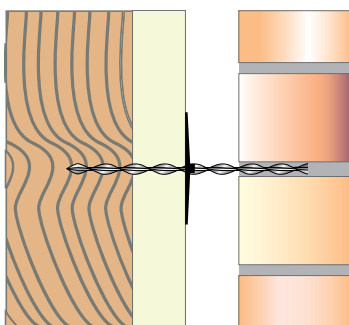

Starter ties - See thin joint leaflet for details

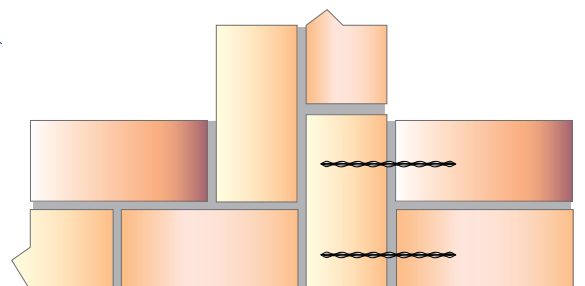

INSTALLATION TOOLS AND EQUIPMENT



SureTwist Hand Support Tool

The Hand Support tool is used to support and guide the SureTwist Ties by conventional hammer force.

It is used in a number of applications, Timber frame ties, Thin Joint ties, Starter ties, Multi Purpose fixings and Warm Roof Fixings.

The tools are available for 4.5, 5, 6, 7, 8, 9 and 10mm diameter ties and in lengths from 50mm to 300mm.

SureTwist SDS Power Attachment

The SDS Power Attachment is used to support and guide the SureTwist ties by hammer action on a SDS power tool.

It is used in a number of applications, Timber Frame, Thin Joint ties, Starter ties and lateral restraint ties.

The tools are available for 7, 8, 9 and 10mm diameter ties and in lengths from 150mm to 480mm.

SureTwist Power Support Tool

The SDS Power Support Tool is used to guide the SureTwist ties by hammer action on a SDS power tool.

Used in a number of applications, Mechanical Remedial Wall ties and Warm Roof fixings. The tools are available in 6, 7, 8, 9 and 10mm.

SureTwist Power Support Tool 45

The SDS Power Support Tool 45 is used to guide the SureTwist ties at an angle of 45° by hammer action on a SDS power tool.

For use with Mechanical Remedial wall ties. The Tools are available in 8, 9 and 10mm.

CONSTRUCTION PRODUCTS SOLUTIONS INTERNATIONAL LTD.

Unit 3, Haslemere Industrial Estate, Pig Lane, Bishop's Stortford, Hertfordshire. CM23 3HG. United Kingdom.
Tel: +44(0)1279 505 514 - Fax: +44(0)1279 755190 - e mail: info@surecps-group.com - www.surecps-group.com
Company Reg. 6969591 VAT Reg. GB 824 4246 40



INSTALLATION TOOLS AND EQUIPMENT



SureTwist Warm Roof Alignment / Support Tool

Used to support and align warm roof fixings.
Size 6, TC7 and 8mm.



SureTwist Grout Tie Pinning Nozzle

Used to simultaneously inject both the SureGrout and either 8mm, TC8mm, TC9mm or 10mm SureTwist bars, allowing the tie to be fully embedded in grout along the whole length of the clearance hole.

The nozzles are available in lengths from 200mm to 1000mm.



SureBrush Applications:

For cleaning black crack stitching/grout tie gun tube - cleaning grout tie nozzle and cleaning drilled holes.

Sizes: 9mm x 650mm – 68mm x 350mm

Sold separately or with crack stitching/grout tie gun kits.



SureTwist Heavy Duty Grout Tie Gun

Used with the grout tie nozzles to simultaneously inject SureGrout and 8mm helical section.

Used with Grout Ties

Size 600ml 18:1 gear ratio



SureTwist Crack Stitching Pointing Gun

Used to insert SureGrout into mortar joints and with the grout tie nozzles to simultaneously inject SureGrout and 8mm helical section.

Used for Crack-stitching, Beaming and Grout Ties
Size 600ml 12:1 gear ratio.

CONSTRUCTION PRODUCTS SOLUTIONS INTERNATIONAL LTD.

Unit 3, Haslemere Industrial Estate, Pig Lane, Bishop's Stortford, Hertfordshire. CM23 3HG. United Kingdom.
Tel: +44(0)1279 505 514 - Fax: +44(0)1279 755190 - e mail: info@surecps-group.com - www.surecps-group.com
Company Reg. 6969591 VAT Reg. GB 824 4246 40



INSTALLATION TOOLS AND EQUIPMENT



SureBond Resin Applicator Gun

Used with SureBond Polyester Resin

Size 380 / 400 ml



SureBond Application Gun

Used with SureBond TE Resin and DryTech Injection Cream.

Size 400 ml



SureTwist Crack-stitching Nozzle

Used to insert SureGrout into the mortar joint.

Used for Crack-stitching and Beaming
Size 9.5mm



SureTwist Mixing Paddle

Used to mix SureGrout

Size 80mm



SureTwist Finger Trowel

Used for Crack-stitching and Beaming

Size 10mm



SureDrill SDS drill bits

A complete range of drill bits designed to be used with all CPSI products

CONSTRUCTION PRODUCTS SOLUTIONS INTERNATIONAL LTD.

Unit 3, Haslemere Industrial Estate, Pig Lane, Bishop's Stortford, Hertfordshire. CM23 3HG. United Kingdom.
Tel: +44(0)1279 505 514 - Fax: +44(0)1279 755190 - e mail: info@surecps-group.com - www.surecps-group.com
Company Reg. 6969591 VAT Reg. GB 824 4246 40



REMEDIAL CRACK-STITCHING SYSTEM BOX

The only fully certified helical crack-stitching system on the market.
A two component system consisting of stainless steel SureTwist Bar and SureGrout



Crack-Stitching Box Contents:

- 10 No 6mm x 1000mm SureTwist Bar
- 1 No 3 Ltr Tub of SureGrout
- 1 No Crack-Stitching Gun
- 1 No Stainless Steel Nozzle
- 1 No Mixing Paddle
- 1 No Finger Trowel

SureFill



Crack & Mortar filler

CRACK-STITCHING AND GROUT TIE NOZZLE ASSEMBLY



Drive the Grout Tie nozzle inside the black plastic nozzle.



Make sure that the Grout Tie Nozzle is pressed as far as possible into the black plastic nozzle.



Slide the aluminum collar down the Grout Tie Nozzle and over the black plastic nozzle. Then tighten the wing nut, ensuring that there is a tight seal between the Grout Tie Nozzle and the black plastic nozzle.



Stainless Steel Crack-stitching nozzle together with the Black plastic nozzle.

Construction Products Solutions Recommend the use PPE Clothing and Protection Equipment for all SureTwist applications.

CONSTRUCTION PRODUCTS SOLUTIONS INTERNATIONAL LTD.

Unit 3, Haslemere Industrial Estate, Pig Lane, Bishop's Stortford, Hertfordshire. CM23 3HG. United Kingdom.
Tel: +44(0)1279 505 514 - Fax: +44(0)1279 755190 - e mail: info@surecps-group.com - www.surecps-group.com
Company Reg. 6969591 VAT Reg. GB 824 4246 40











Please always wear the appropriate safety and protective clothing when installing fixing and anchor products. Always observe the necessary Health & Safety guidelines.

© All text copyright. Above information is given as guidance only and should always be verified by a suitable engineer.

The above information is given in good faith, and may be subject to alteration at any time without prior notification.

SURETWIN PRODUCTION FACILITY



-  Refurbishment & Masonry Repair
-  General Construction & Civil Engineering
-  New Build Housing
-  Cladding / Facades & Curtain Wall
-  Mechanical, Electrical - Heating & Ventilation
-  Oil & Gas
-  Railway
-  Nuclear
-  Eco Build

The Brutt Saver Group was founded in 1998 in Germany by Alexander and Daniela Brütt.



CONSTRUCTION PRODUCTS SOLUTIONS INTERNATIONAL LTD.

Unit 3, Haslemere Industrial Estate, Pig Lane, Bishop's Stortford, Hertfordshire. CM23 3HG. United Kingdom.
 Tel: +44(0)1279 505 514 - Fax: +44(0)1279 755190 - e mail: info@surecps-group.com - www.surecps-group.com
 Company Reg. 6969591 VAT Reg. GB 824 4246 40



Please always wear the appropriate safety and protective clothing when installing fixing and anchor products. Always observe the necessary Health & Safety guidelines.

© All text copyright. Above information is given as guidance only and should always be verified by a suitable engineer.

The above information is given in good faith, and may be subject to alteration at any time without prior notification.