

Allgemeine bauaufsichtliche Zulassung

Zulassungsstelle für Bauprodukte und Bauarten

Bautechnisches Prüfamt

Eine vom Bund und den Ländern
gemeinsam getragene Anstalt des öffentlichen Rechts

Mitglied der EOTA, der UEAtc und der WFTAO

Date:

14 July 2021

Reference:

I 25-1.21.8-32/21

Approval number:

Z-21.8-2049

Applicant:

fischerwerke GmbH & Co. KG

Klaus-Fischer-Straße 1

72178 Waldachtal

Validity

from: 14 July 2021

to: 14 July 2026

Subject of approval:

fischer concrete screw ULTRACUT FBS II for the temporary fastening of building site equipment

The subject of approval named above is herewith granted a national technical approval (*allgemeine bauaufsichtliche Zulassung*).

This national technical approval (*allgemeine bauaufsichtliche Zulassung*) contains five pages and five annexes.

Translation

DIBt

I GENERAL PROVISIONS

- 1 With the national technical approval (*allgemeine bauaufsichtliche Zulassung*) the fitness for use and the applicability of the subject of approval in accordance with the Building Codes of the federal states (*Landesbauordnungen*) have been verified.
- 2 If in the national technical approval (*allgemeine bauaufsichtliche Zulassung*) requirements are made concerning the special expertise and experience of persons entrusted with the manufacture of construction products and types of construction in accordance with the provisions of the relevant federal state following Section 17 Sub-Section 5 of the Model Building Code (*Musterbauordnung*), it shall be noted that this expertise and experience can also be proven by equivalent verifications from other Member States of the European Union. If necessary, this also applies to verifications presented within the framework of the Agreement on the European Economic Area (EEA) or other bilateral agreements.
- 3 The national technical approval (*allgemeine bauaufsichtliche Zulassung*) does not replace the permits, approvals and certificates prescribed by law for carrying out building projects.
- 4 The national technical approval (*allgemeine bauaufsichtliche Zulassung*) will be granted without prejudice to the rights of third parties, in particular private property rights.
- 5 Notwithstanding further provisions in the 'Special Provisions', manufacturers and distributors of the subject of approval shall make copies of the national technical approval (*allgemeine bauaufsichtliche Zulassung*) available to the user and point out that the national technical approval (*allgemeine bauaufsichtliche Zulassung*) shall be available at the place of use. Upon request, copies of the national technical approval (*allgemeine bauaufsichtliche Zulassung*) shall be placed at the disposal of the authorities involved.
- 6 The national technical approval (*allgemeine bauaufsichtliche Zulassung*) may be reproduced in full only. Partial publication requires the consent of Deutsches Institut für Bautechnik. Texts and drawings contained in advertising literature may not be in contradiction to the national technical approval (*allgemeine bauaufsichtliche Zulassung*). In the event of a discrepancy between the German original of the national technical approval (*allgemeine bauaufsichtliche Zulassung*) and this authorised translation, the German version shall prevail.
- 7 The national technical approval (*allgemeine bauaufsichtliche Zulassung*) is granted until revoked. The provisions of the national technical approval (*allgemeine bauaufsichtliche Zulassung*) can subsequently be supplemented and amended, in particular if this is required by new technical findings.

II SPECIAL PROVISIONS

1 Subject of approval and field of application

1.1 Subject of approval

This general type of approval regulates the planning, dimensioning and execution of the Temporary anchoring in the concrete using the Fischer concrete screw UltraCut FBS II (hereinafter referred to as the anchor) in accordance with the European technical assessment ETA-15/0352 from 05.10.2020.

The anchor is installed by screwing it into a pre-drilled cylindrical borehole. The special thread of the anchor cuts a thread in the anchoring base. The anchor takes place through the form fit of the special thread in the concrete.

Annex 1 shows the installed anchorage.

1.2 Field of application

The anchor may be used in reinforced and un-reinforced normal weight concrete of strength class C20/25 at minimum and strength class C50/60 at maximum in accordance with DIN EN 206:2014-07 'Concrete - Specification, properties, production and conformity'. The screw may be used as stated in Section 4.1 until the required characteristic compressive strength of the concrete is reached by verification.

The anchor may only be used for the temporary fastening of building site equipment, e.g. braces for formwork, fall protection equipment and scaffolding. After unscrewing the anchor, it can be reused in other drill holes. After unscrewing FBS II from a drill hole, this drill hole may not be used a second time. Every time before reusing the anchor, it shall be checked visually using a checking gauge in accordance with Section 4.3. Installed anchors shall be checked regularly for visible damages (e.g. corrosion).

The anchor may be used in cracked and non-cracked concrete.

The anchor may only be used in situations where no fire resistance requirements apply to the entire structure including the screw.

The anchor may only be used for temporary fastening applications in internal and external conditions.

2 Provisions for planning, design and execution

2.1 Planning

The anchor shall be planned by engineers. Considering the anchored loads are verifiable calculations and design drawings to make.

The construction drawings must show the exact position, size, and screw-in depth of the anchor included.

2.2 Design

The verification of the immediate local force application in the concrete is with this assessment done. The transmission of the loads to be anchored in the component must be verified.

Additional stresses in the anchor, in the component to be connected or in the component in which the anchor is anchored, from impeded deformation (e.g., with temperature changes) may arise must be considered.

The minimum distances of the anchor (spacing, edge distances) and the minimum concrete thickness according to Annex 4 must be complied with.

The minimum installation parameters of the anchor (spacing, edge distances) and the minimum thickness of the concrete member shall not be less than the values stated in Annex 4.

It shall be proven that the design action F_{Ed} does not exceed the value of the design resistance F_{Rd} :

$$F_{Ed} \leq F_{Rd}$$

The design values of the resistance are valid for all load directions (except shear loads in direction c_2 , see Annex 4), regardless of the failure mode. The resistances are stated in Annex 4 depending on the screw size, the screw-in depth and the concrete strength $f_{c,cube}$.

2.3 Provisions for execution

2.3.1 General

The anchor shall be installed in accordance with the design drawings stated in Section 3.1. The screw may be used in the concrete member before reaching the characteristic compressive strength $f_{ck,cube}$. In this case, the concrete compressive strength $f_{c,cube}$ must have reached a value of at least 10 N/mm².

2.3.2 Drilling and cleaning the bore hole

The position of the drill hole must be chosen such that the reinforcement does not get damaged.

The drill hole shall be drilled by using a hard metal hammer drill bit, hollow drill bit or diamond drill bit. It shall be drilled perpendicular to the surface of the base material. The nominal drill diameter and the cutting diameter shall correspond to Annex 3.

In addition to this, the masonry drill bit shall correspond to the specifications listed in the following leaflet issued by Deutsches Institut für Bautechnik: Characteristic values, requirements and tests of masonry drills with carbide metal cutting elements used for setting drill holes for anchor installations (*Kennwerte, Anforderungen und Prüfungen von Mauerbohrern mit Schneidkörpern aus Hartmetall, die zur Herstellung der Bohrlöcher von Dübelverankerungen verwendet werden*) (version January 2002).

Compliance with the characteristic values of the drills shall be proven by means of an inspection certificate 3.2 (DIN EN 10204) or by the inspection mark (see information sheet) of test association Prüfgemeinschaft Mauerbohrer e.V., Remscheid.

The drill hole depth shall correspond to the values given in Annex 3. The drill dust shall be removed from the drill hole (for exceptions, see Annex 3).

In case of an aborted drill hole, a new drill hole shall be drilled with a distance of at least 2x depth of the aborted drill hole.

2.3.3 Installation of the screw

The anchor may only be used temporarily in a single drill hole. After it is unscrewed, it can be reused in other drill holes. However, it shall not be used twice in the same drill hole.

Every time before reusing FBS II, the wear of the thread shall be checked using the relevant checking gauge as stated in Annex 2. The anchor may be reused only if it can penetrate the gauge without protruding from the end of the checking gauge (see Annex 5). Screws with obvious damage, e.g. corrosion, must not be reused.

The anchor may be screwed in using an impact driver. To avoid over-turning of the screws, the impact driver should have a maximum power output as stated in Annex 3, Table 2, and should be equipped with an automatic shut-down device.

The anchor is installed correctly when

- the base plate to be fixed (fixture) is completely screwed to the concrete without any intermediate layer.
- the head of the anchor is supported on the fixture
- it is not possible to turn the screw anymore,
- the setting depth h_{nom} is observed.

2.3.4 Inspection of execution

During the installation of the anchors, the contractor responsible for installing the anchorages or the construction supervisor assigned by him or a competent representative of the construction supervisor shall be present at the job site. He shall ensure the proper installation of the anchors.

During the installation of the anchors, records on the verification of the existing concrete strength class in accordance with Section 4.1 and the proper installation of the anchors shall be maintained by the construction supervisor or his competent representative.

The records shall be available at the job site during the construction period and shall be presented to the person carrying out the inspection upon request. These records as well as the delivery notes shall be kept by the company for at least five years after completion of the work.

Beatrix Wittstock
Head of Section

Notarized

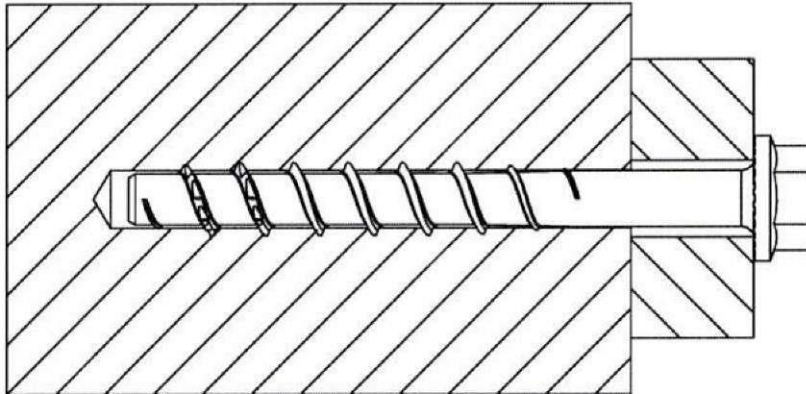

FBS II US

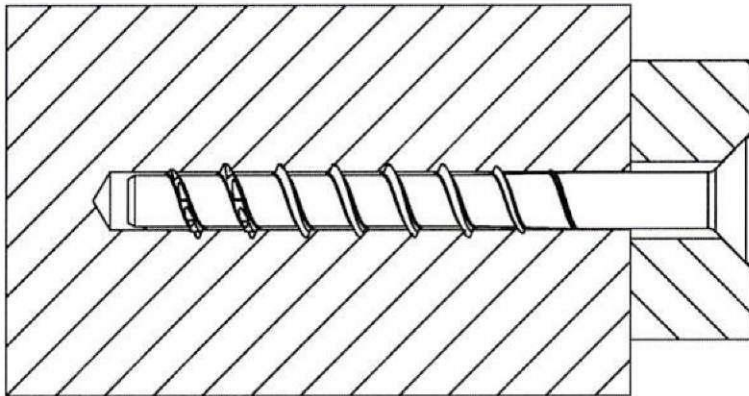

FBS II SK

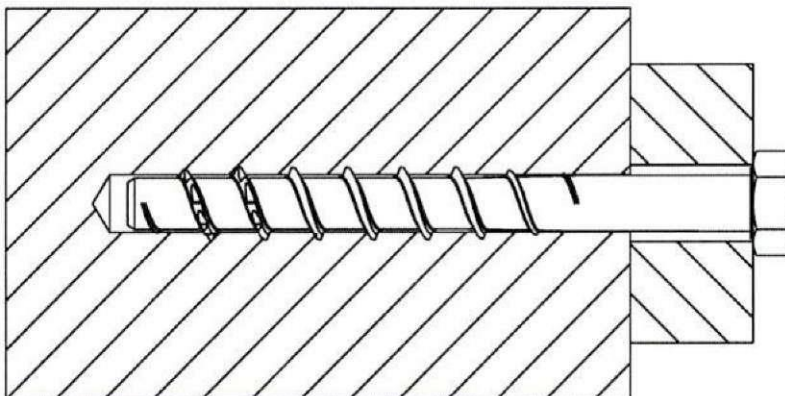

FBS II S

fischer concrete screw ULTRACUT FBS II for the temporary fastening of building site equipment

Installed screw

Annex 1

Table 1: Dimensions and screw types

Screw type / size			FBS II US / SK / S (Tx)			
			8	10	12	14
Outer thread diameter	d_a	[mm]	10.3	12.5	14.5	16.6
Core diameter	d_k	[mm]	7.4	9.4	11.3	13.3
Shaft diameter	d_s	[mm]	8.0	9.9	11.7	13.7
Diameter of formed washer	$U_{d u}$	[mm]	18.0	20.5	23.0	28.0
Gauge inner diameter	d_{HL}	[mm]	9.9	12.0	13.9	15.6
Gauge length	L_{HL}	[mm]	25	30	35	40
Material			Hardened carbon steel; $A_{5\%} \geq 8\%$			
Coating			Zinc plated			

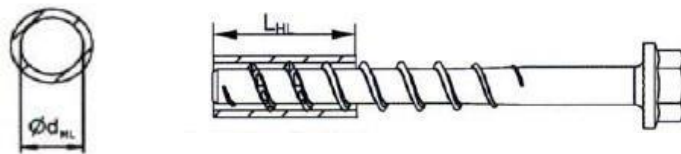
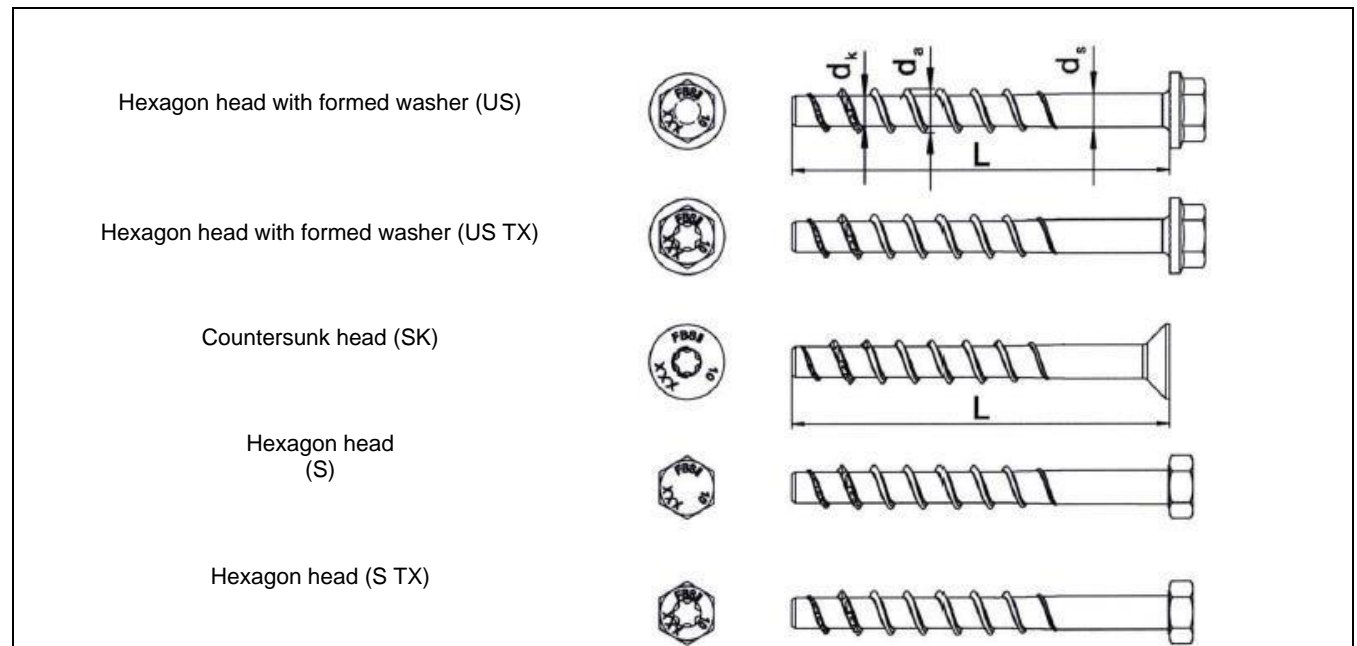

Head Marking:
 1 FBS II: Product description
 2 10: Screw size
 3 XXX: Screw length

Checking gauge FUP imprint
 FUP 10 10 screw diameter
 FUL fischer ULTRACUT checking gauge
 fischer manufacturer label

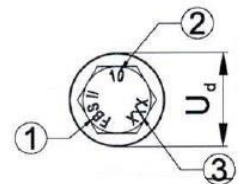

fischer concrete screw ULTRACUT FBS II for the temporary fastening of building site equipment

Dimensions and screw types
Reusability

Annex 2

Table 2: Installation parameters

Screw size			FBS II										
			8		10			12			14		
Nominal anchorage depth	h_{nom}	[mm]	50	65	55	65	85	60	75	100	65	85	115
Nominal drill hole diameter	d_0	[mm]	8		10			12			14		
Cutting diameter of drill bit													
Hammer drilling	$d_{cut} \leq$	[mm]	8.45		10.45			12.5			14.5		
Hollow drilling	$d_{cut} \leq$	[mm]	8.45		10.45			12.5			14.5		
Diamond drilling	d_{cut}	[mm]	8.05-8.45		10.05-10.45			12.10-12.50			14.10-14.50		
Clearance hole diameter (fixture)	d_f	[mm]	10.6-12.0		12.8-14.0			14.6-16.0			16,9- 18,0		
Wrench size (US,S)	SW	[mm]	13		15			17			21		
Torx size	Tx		40		50			-			-		
Countersunk head diameter	d_h	[mm]	18		21			-			-		
Countersunk head height	x	[mm]	6		7			-			-		
Countersunk hole diameter in the fixture	S_d	[mm]	20		23			-			-		
Drill hole depth ¹⁾	$h_1 \geq$	[mm]	60	75	65	75	95	70	85	110	80	100	130
Thickness of the fixture	$T_{fix}^{3)} \geq$	[mm]	0										
	$T_{fix} \leq$	[mm]	$L - h_{nom}$										
Length of screw	$L_{min}^{4)} =$	[mm]	50	65	55	65	85	60	75	100	65	85	115
	$L_{max} =$	[mm]	400	415	405	415	435	410	425	450	415	435	465
Torque impact screwdriver ²⁾	$T_{imp,max}$	[Nm]	400	400	400	400	650	400	400	650	400	400	650

1) The drill hole does not need to be cleaned if a hollow drill bit is used or:
- if drilling vertical upwards
- if drilling vertical downwards and the drill hole depth has been increased by at least $3 \times d_0$.

2) Installation with any torque impact screwdriver up to the maximum torque moment ($T_{imp,max}$) mentioned. Alternatively, other tools without a torque mentioned are allowed (e.g. ratchet spanner). After installation of the screw, it must be impossible to turn the screw any further. The head of the screw shall be tight down to the fixture and may not be damaged. The torque moments $T_{imp,max}$ are not valid for manual installation (e.g. torque wrench).

3) For countersunk screws the height of the head shall be added to t_{fix} .
4) For countersunk screws the height of the head shall be added to L_{min} .

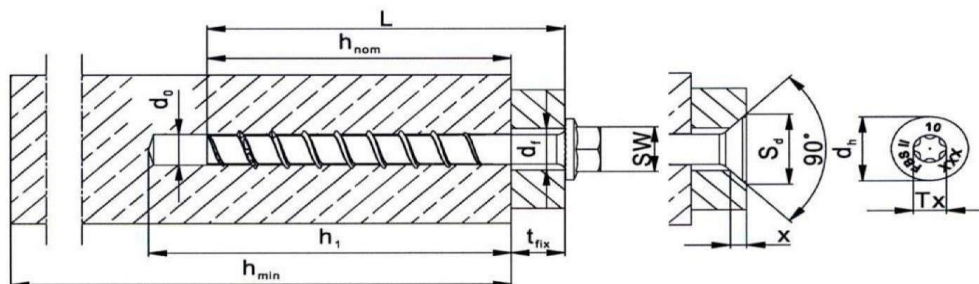

fischer concrete screw ULTRACUT FBS II for the temporary fastening of building site equipment

Installation parameters

Annex 3

Table 3: Minimum concrete member thickness, minimum spacing and edge distances in cracked and non-cracked concrete

Screw size			FBS II										
			8		10			12			14		
Nominal anchorage depth	h_{nom}	[mm]	50	65	55	65	85	60	75	100	65	85	115
Minimum thickness of concrete member	h_{min}	[mm]	100	150	105	130	205	120	150	240	115	150	255
Minimum spacing	s	[mm]	200	300	210	260	410	240	300	480	230	300	510
Minimum edge distance	c_1	[mm]	65	100	70	85	135	80	100	160	75	100	170
Minimum edge distance	c_2	[mm]	100	150	105	130	205	120	150	240	115	150	255

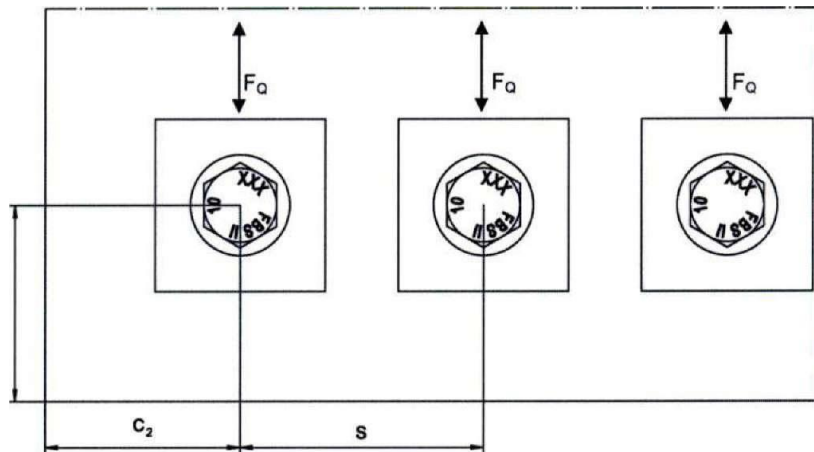

Table 4: Design resistance for all load directions in cracked and non-cracked concrete of compressive strength class $\geq C20/25$ and $\leq C50/60$

Screw size			FBS II										
			8		10			12			14		
Nominal anchorage depth	h_{nom}	[mm]	50	65	55	65	85	60	75	100	65	85	115
Resistance for concrete compressive strength $f_{c,cube} \geq 10 \text{ N/mm}^2$	$F_{Rd}^{1)}$	[kN]	2.6	5.0	3.1	4.0	8.1	3.9	5.6	10.6	3.2	5.0	12.4
Resistance for concrete compressive strength $f_{c,cube} \geq 15 \text{ N/mm}^2$	$F_{Rd}^{1)}$	[kN]	3.2	6.1	3.8	4.9	9.9	4.7	6.8	13.0	3.9	6.1	15.2
Resistance for concrete compressive strength $f_{c,cube} \geq 20 \text{ N/mm}^2$	$F_{Rd}^{1)}$	[kN]	3.7	7.1	4.4	5.7	11.4	5.5	7.9	15.1	4.5	7.0	17.6
Resistance for concrete compressive strength $f_{c,cube} \geq 25 \text{ N/mm}^2$	$F_{Rd}^{1)}$	[kN]	4.1	7.9	4.9	6.3	12.8	6.2	8.5	16.8	5.1	7.9	19.6

¹⁾ Includes material safety factor

fischer concrete screw ULTRACUT FBS II for the temporary fastening of building site equipment

Annex 4

Minimum concrete member thickness, minimum spacing and edge distances, design resistance for all load directions

Installation instruction

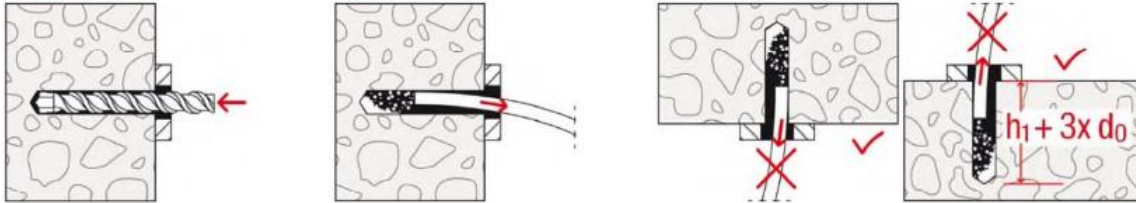

Drill hole by using hammer drill bit, hollow drill or dia- mond core drill bit.

Clean the drill hole. Step 2 can be omitted (completely) if the drill hole is produced by a hollow drill bit.

Cleaning is not necessary if drilling vertically upwards or vertically downwards and the drill hole depth is increased by at least $3 \times d_0$.

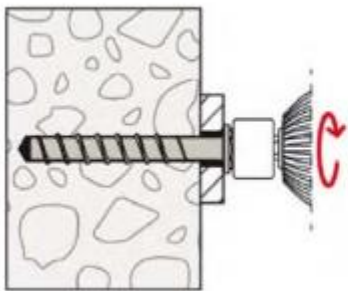

Installation with any torque impact screw driver up to the maximum torque ($T_{imp,max}$) mentioned. Alternatively, all other tools without an indicated torque moment are allowed (e.g., ratchet spanner).

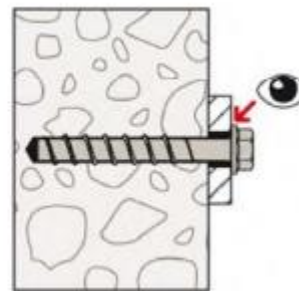

After installation, further turning of the screw may not be possible. The head of the screw must be tight down to the fixture and may not be damaged.

Reusability check

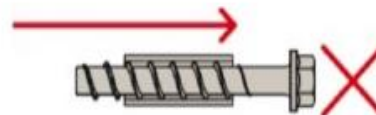

The concrete screw must be checked for damage (e.g., corrosion) every time before it is reused and be replaced, if necessary.

Once the screw protrudes from the end of the checking gauge, the screw is no longer suitable for reuse.

fischer concrete screw ULTRACUT FBS II for the temporary fastening of building site equipment

Installation instruction, reusability

Annex 5