

Approval body for construction products  
and types of construction

Bautechnisches Prüfamt

An institution established by the Federal and  
Laender Governments



## European Technical Assessment

ETA-22/0551  
of 24 October 2022

English translation prepared by DIBt - Original version in German language

### General Part

Technical Assessment Body issuing the  
European Technical Assessment:

Deutsches Institut für Bautechnik

Trade name of the construction product

Concrete Screw BSZ2

Product family  
to which the construction product belongs

Mechanical fasteners for use in concrete

Manufacturer

MKT  
Metall-Kunststoff-Technik GmbH & Co. KG  
Auf dem Immel 2  
67685 Weilerbach  
DEUTSCHLAND

Manufacturing plant

MKT Werk 5, D

This European Technical Assessment  
contains

17 pages including 3 annexes which form an integral part  
of this assessment

This European Technical Assessment is  
issued in accordance with Regulation (EU)  
No 305/2011, on the basis of

EAD 330232-01-0601, Edition 05/2021

The European Technical Assessment is issued by the Technical Assessment Body in its official language. Translations of this European Technical Assessment in other languages shall fully correspond to the original issued document and shall be identified as such.

Communication of this European Technical Assessment, including transmission by electronic means, shall be in full. However, partial reproduction may only be made with the written consent of the issuing Technical Assessment Body. Any partial reproduction shall be identified as such.

This European Technical Assessment may be withdrawn by the issuing Technical Assessment Body, in particular pursuant to information by the Commission in accordance with Article 25(3) of Regulation (EU) No 305/2011.

**Specific Part**

**1 Technical description of the product**

The concrete screw BSZ2 is an anchor in size 6, 8 and 10 mm made of stainless steel. The anchor is screwed into a predrilled cylindrical drill hole. The special thread of the anchor cuts an internal thread into the member while setting. The anchorage is characterised by mechanical interlock in the special thread.

Product and product description are given in Annex A.

**2 Specification of the intended use in accordance with the applicable European Assessment Document**

The performances given in Section 3 are only valid if the concrete screw is used in compliance with the specifications and conditions given in Annex B.

The verifications and assessment methods on which this European Technical Assessment is based lead to the assumption of a working life of the concrete screw of at least 50 years. The indications given on the working life cannot be interpreted as a guarantee given by the producer, but are to be regarded only as a means for choosing the right products in relation to the expected economically reasonable working life of the works.

**3 Performance of the product and references to the methods used for its assessment**

**3.1 Mechanical resistance and stability (BWR 1)**

Essential characteristic	Performance
Characteristic resistance to tension load (static and quasi-static loading)	See Annex B2 and C1
Characteristic resistance to shear load (static and quasi-static loading)	See Annex C2
Displacements (static and quasi-static loading)	See Annex C5
Characteristic resistance and displacements for seismic performance categorie C1	See Annex C3

**3.2 Safety in case of fire (BWR 2)**

Essential characteristic	Performance
Reaction to fire	Class A1
Resistance to fire	See Annex C4

**3.3 Aspects of durability linked with the Basic Works Requirements**

Essential characteristic	Performance
Durability	See Annex B1

**4 Assessment and verification of constancy of performance (AVCP) system applied, with reference to its legal base**

In accordance with European Assessment Document EAD No. 330232-01-0601 the applicable European legal act is: [96/582/EC].

The system to be applied is: 1

**5 Technical details necessary for the implementation of the AVCP system, as provided for in the applicable European Assessment Document**

Technical details necessary for the implementation of the AVCP system are laid down in the control plan deposited at Deutsches Institut für Bautechnik.

Issued in Berlin on 24 October 2022 by Deutsches Institut für Bautechnik

Dipl.-Ing. Beatrix Wittstock  
Head of Section

*beglaubigt:*  
Baderschneider

## Concrete Screw BSZ2

- stainless steel A4
- high corrosion resistant steel HCR

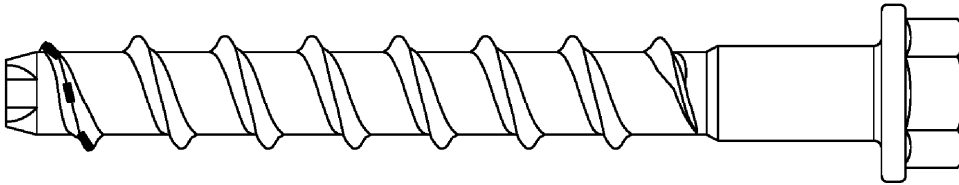

e.g. Concrete Screw BSZ2 with hexagon head and pressed-on washer

### Installation condition

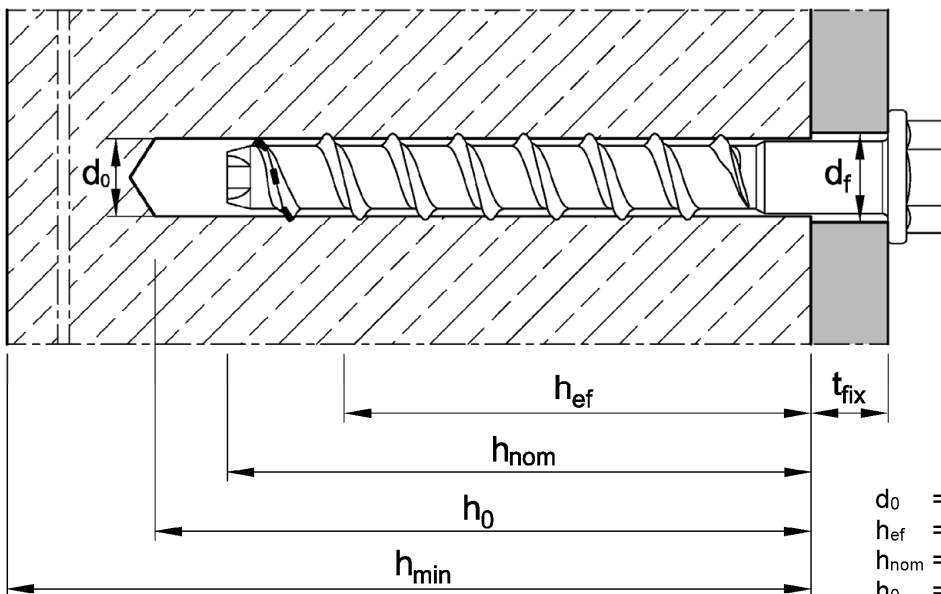

- $d_0$  = nominal drill bit diameter
- $h_{ef}$  = effective anchorage depth
- $h_{nom}$  = nominal embedment depth
- $h_0$  = depth of the drill hole
- $h_{min}$  = minimum thickness of member
- $t_{fix}$  = thickness of fixture
- $d_f$  = diameter of clearance hole in the fixture

**Filling washer and reducing adapter (optional)**  
for filling the annular gap between concrete screw and fixture

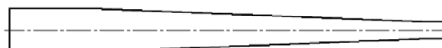
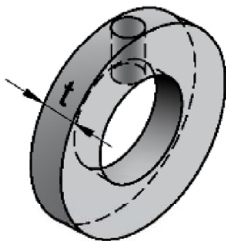



## Concrete Screw BSZ2

**Product description**  
Product and installation condition

**Annex A1**

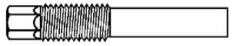
**Table A1: Anchor types**

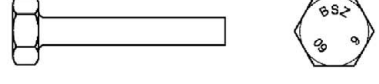
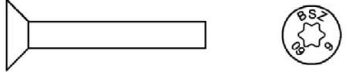
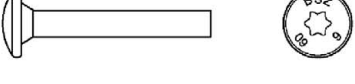
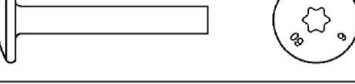
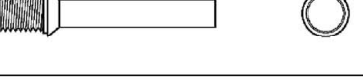
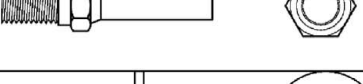
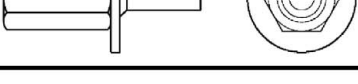
Type		Description
B		Anchor version with metric connection thread and hexagon drive e.g.: BSZ2-B 10x140 A4
S		Anchor version with hexagon head, pressed-on washer and TORX drive e.g.: BSZ2-SU 10x140 A4 TX
		Anchor version with hexagon head and pressed-on washer e.g.: BSZ2-SU 10x140 A4
		Anchor version with hexagon head e.g.: BSZ2-S 10x140 A4
SK		Anchor version with countersunk head and TORX drive e.g.: BSZ2-SK 10x140 A4
LK		Anchor version with pan head and TORX drive e.g.: BSZ2-LK 10x140 A4
		Anchor version with large pan head and TORX drive e.g.: BSZ2-GLK 10x140 A4
BS		Anchor version with countersunk head and metric connection thread e.g.: BSZ2-BSK 10x140 A4
		Anchor version with hexagon drive and metric connection thread e.g.: BSZ2-BS 10x140 A4
M		Anchor version with internal thread and hexagon drive e.g.: BSZ2-M 10x140 A4

**Concrete Screw BSZ2**

**Product description**  
Anchor types

**Annex A2**

**Table A2: Dimensions**

Screw size			BSZ2 6			BSZ2 8			BSZ2 10		
Nominal embedment depth	$h_{nom}$	[mm]	35 <sup>1)</sup>	45	55	45	55	65	55	75	85
Length of the anchor	$L \leq$	[mm]	500								
Core diameter	$d_k$	[mm]	5,1			7,2			9,2		
Outside diameter	$d_s$	[mm]	7,6			10,5			12,5		
Thickness of filling washer	$t$	[mm]	5			5			5		

<sup>1)</sup> Only for statically indeterminate non-structural systems (multiple use) according to EN 1992-4:2018, in dry internal conditions.

**Marking** e.g.:  $\diamond$  BSZ 10 100  
or TSM 10 100

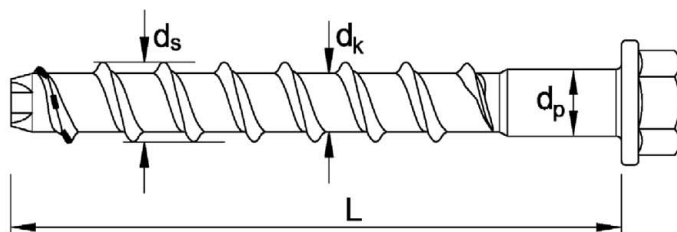

$\diamond$  BSZ Trade name  
or (optional with manufacturer identification  $\diamond$ )  
TSM  
10 Anchor size  
100 Length of anchor

additional marking:

A4 stainless steel, or  
HCR high corrosion resistant steel

**Table A3: Materials**

Version	Stainless steel BSZ2 A4	High corrosion resistant steel BSZ2 HCR
Material numbers	1.4401, 1.4404, 1.4571, 1.4578	1.4529
Characteristic yield strength	$f_{yk}$	560 N/mm <sup>2</sup>
Characteristic ultimate strength	$f_{uk}$	700 N/mm <sup>2</sup>
Fracture elongation	A5	$\leq 8\%$

**Concrete Screw BSZ2**

**Product description**  
Dimensions, marking and materials

**Annex A3**

## Specifications of Intended use

Concrete screw BSZ		BSZ2 6			BSZ2 8			BSZ2 10		
Nominal embedment depth $h_{nom}$		$h_{nom1}^{1)}$	$h_{nom2}$	$h_{nom3}$	$h_{nom1}$	$h_{nom2}$	$h_{nom3}$	$h_{nom1}$	$h_{nom2}$	$h_{nom3}$
[mm]		35	45	55	45	55	65	55	75	85
Anchorage subject to	Static or quasi-static action	✓								
	Fire exposure	✓								
	Seismic action, performance category C1	Tension load:		all anchor types						
		Shear load:		anchor types B, S, SK, LK						
		2)	✓	✓	✓	2)	✓	✓	2)	✓
Base material	Cracked or uncracked concrete	✓								
	Compacted, reinforced or unreinforced concrete without fibres acc. to EN 206:2013+A1:2016	✓								
	Strength classes according to EN 206:2013+A1:2016, C20/25 to C50/60	✓								

1) Only for statically indeterminate non-structural systems (multiple use) according to EN 1992-4:2018, in dry internal conditions.

2) no performance assessed

### Use conditions (Environmental conditions):

- Structures subject to dry internal conditions: all screw types
- For all other conditions corresponding to corrosion resistance classes CRC according to EN 1993-1-4:2006 +A1:2015:
  - stainless steel A4, according to Annex A3, Table A3: CRC III
  - high corrosion resistant steel HCR, according to Annex A3, Table A3: CRC V

### Design:

- Anchorage are designed under the responsibility of an engineer experienced in anchorages and concrete work.
- Verifiable calculation notes and drawings are prepared taking account of the loads to be anchored. The position of the anchor is indicated on the design drawings (e.g. position of the anchor relative to reinforcement or to supports, etc.)
- Design method of anchorages according to EN 1992-4:2018 (if required in connection with EOTA Technical Report TR 055, version February 2018)

### Installation:

- Making of drill hole by hammer drilling (all sizes) or vacuum drilling (BSZ 8 und BSZ 10). When using a vacuum drill bit no drill hole cleaning is required.
- Anchor installation carried out by appropriately qualified personal and under the responsibility of the person responsible for technical matters on site.
- After installation further turning of the anchor is not possible. The head of the anchor is supported on the fixture and is not damaged.
- The borehole may be filled with the Injection System VME plus.
- Adjustment according to Annex B4 (except for anchorages with filled borehole and anchorages with seismic action).

<b>Concrete Screw BSZ2</b>	<b>Annex B1</b>
<b>Intended Use Specifications</b>	

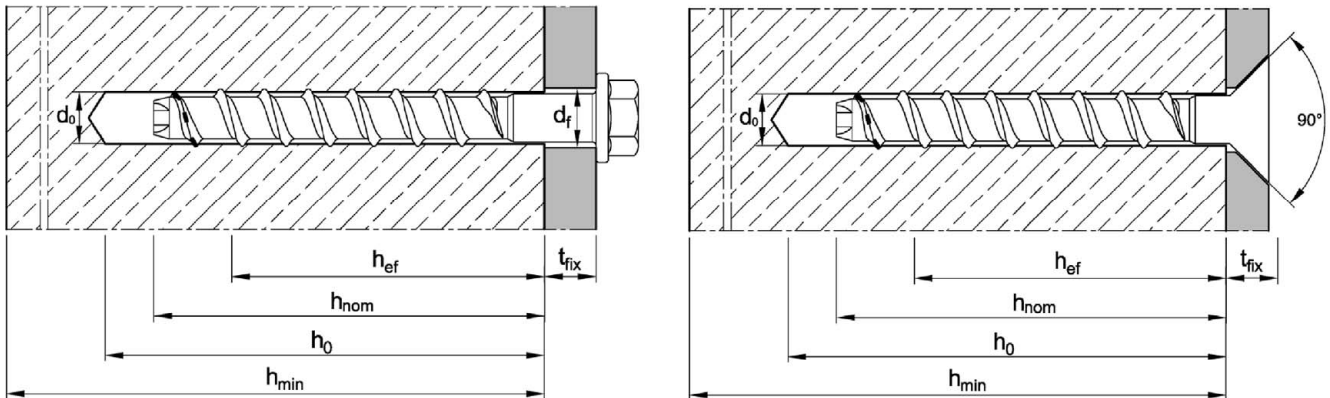

**Table B1: Installation parameters**

Screw size			BSZ2 6			BSZ2 8			BSZ2 10		
Nominal embedment depth	$h_{nom}$	[mm]	35 <sup>1)</sup>	45	55	45	55	65	55	75	85
Nominal drill bit diameter	$d_0$	[mm]	6			8			10		
Cutting diameter of drill bit	$d_{cut} \leq$	[mm]	6,40			8,45			10,45		
Depth of drill hole	$h_0 \geq$	[mm]	40	50	60	55	65	75	65	85	95
Diameter of clearance hole in the fixture	$d_f \leq$	[mm]	8			12			14		
Max. installation torque for screws with metric connection thread	$T_{inst} \leq$	[Nm]	10			20			40		
Tangential impact screw driver <sup>2)</sup>	$T_{imp,max}$	[Nm]	160			300			450		

<sup>1)</sup> Only for statically indeterminate non-structural systems (multiple use) according to EN 1992-4:2018, in dry internal conditions.

<sup>2)</sup> Installation with tangential impact screw driver, with maximum torque  $T_{imp,max}$  acc. to manufacturer's instructions is possible.



**Table B2: Minimum thickness of member, minimum edge distance and minimum spacing**

Screw size			BSZ2 6			BSZ2 8			BSZ2 10		
Nominal embedment depth	$h_{nom}$	[mm]	35 <sup>1)</sup>	45	55	45	55	65	55	75	85
Minimum thickness of member	$h_{min}$	[mm]	80	80	100	80	100	120	100	130	130
Minimum spacing	$s_{min}$	[mm]	35			35			40		
Minimum edge distance	$c_{min}$	[mm]	35			35			40		

<sup>1)</sup> Only for statically indeterminate non-structural systems (multiple use) according to EN 1992-4:2018, in dry internal conditions.

**Concrete Screw BSZ2**

**Intended Use**

Installation parameters / Minimum thickness of concrete member, minimum spacing and edge distance

**Annex B2**

## Installation instructions

Drill hole preparation and cleaning		
1		Drill hole perpendicular to concrete surface. Using a vacuum drill, continue with step 3.
2		Blow out dust or alternatively vacuum clean down to the bottom of the hole.
Installation concrete screw		
3		Screw in, e.g. with tangential impact screw driver or torque wrench.
4		After installation, the head of the anchor is supported on the fixture and must be undamaged.
For screw size BSZ2 6 with $h_{nom} = 35$ mm, installation only with impact screw drivers.		

### Concrete Screw BSZ2

**Intended Use**  
Installation instructions

**Annex B3**

## Installation instructions - Adjustment

### 1. Adjustment

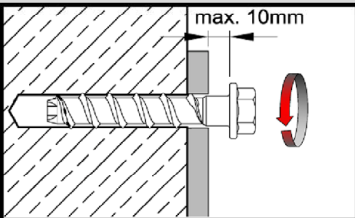
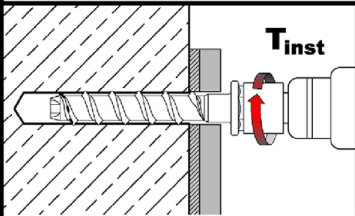
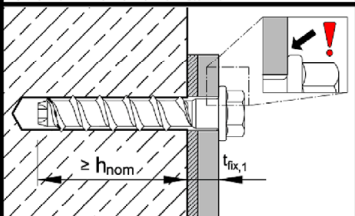
5		Screw may be untightened maximum 10 mm.
6		After adjustment, screw in the concrete screw with tangential impact screw driver or torque wrench.
7		After installation, the head of the anchor is supported on the fixture must be undamaged.

### 2. Adjustment

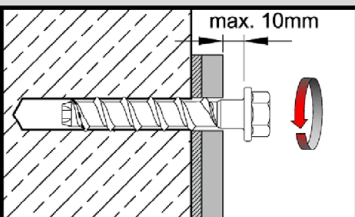
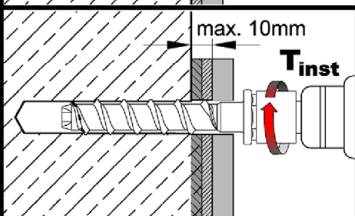
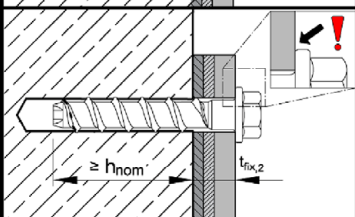
8		Screw may be untightened maximum 10 mm.
9		After adjustment, screw in the concrete screw with tangential impact screw driver or torque wrench.
10		After installation, the head of the anchor is supported on the fixture and must be undamaged.

**Note:**

The concrete screw may be adjusted max. 2 times. The fastener must not be screwed back by more than 10 mm in each case. The relining carried out during adjustment must not exceed 10 mm in total. Nominal embedment depth  $h_{nom}$  must still be maintained after the adjustment.

## Concrete Screw BSZ2

**Intended Use**  
Installation instructions - Adjustment

**Annex B4**

## Installation instructions - filling of annular gap

Drill hole preparation and cleaning		
1		Drill hole perpendicular to concrete surface. Using a vacuum drill, continue with step 3.
2		Blow out dust or alternatively vacuum clean down to the bottom of the hole.
Installation concrete screw with filling washer		
3		Fit the filling washer to the concrete screw or position at the attachment. The thickness of the filling washer must be taken into account with $t_{fix}$ .
4		Screw in, e.g. with tangential impact screw driver or torque wrench.
5		Fill the annular gap between concrete screw and fixture with mortar (compressive strength $\geq 40$ N/mm <sup>2</sup> , e.g. Injection mortar VMH, VMZ or VMU plus). Use enclosed reducing adapter. Observe information on processing of the mortar! The annular gap is completely filled, when excess mortar seeps out.
For seismic loading, the application <u>with</u> and <u>without</u> filling of annular gap is permitted (Annex C3).		

### Concrete Screw BSZ2

**Intended Use**  
Installation instructions - filling of annular gap

**Annex B5**

**Table C1: Characteristic values for tension load under static or quasi-static action**

Screw size			BSZ2 6			BSZ2 8			BSZ2 10			
Nominal embedment depth	$h_{nom}$	[mm]	35 <sup>1)</sup>	45	55	45	55	65	55	75	85	
Installation factor	$\gamma_{inst}$	[-]	1,0									
<b>Steel failure</b>												
Characteristic resistance	$N_{Rk,s}$	[kN]	14,0			27,0			45,0			
Partial factor <sup>2)</sup>	$\gamma_{Ms,N}$	[-]	1,5									
<b>Pull-out failure (concrete strength class C20/25)</b>												
Characteristic resistance	cracked	$N_{Rk,p,cr}$	[kN]	2,5	1,5	3,0	3,0	5,5	8,0	6,0	13,0	17,0
	uncracked	$N_{Rk,p,ucr}$	[kN]	3,5	4,0	8,5	9,0	12,0	17,0	11,0	19,0	25,0
<b>Exponent <math>m</math> for concrete increasing factor <math>\Psi_c = \left(\frac{f_{ck}}{20}\right)^m</math></b>												
Concrete strength class C25/30 to C50/60			$N_{Rk,p} = \psi_c \cdot N_{Rk,p (C20/25)}$									
Exponent $m$	cracked	$m$	[-]	0,41	0,35	0,50	0,50	0,50	0,50	0,50	0,39	0,39
	uncracked	$m$	[-]	0,35	0,50	0,38	0,50	0,50	0,30	0,50	0,50	0,50
<b>Splitting failure</b>												
Case 1	Characteristic resistance	$N^0_{Rk,sp}$	[kN]	$\min(N_{Rk,p}; N^0_{Rk,c})$								
	Characteristic edge distance	$C_{cr,sp}$	[mm]	60	80	120	100	120	145	115	140	160
	Characteristic spacing	$S_{cr,sp}$	[mm]	120	160	240	200	240	290	230	280	320
Case 2	Characteristic resistance	$N^0_{Rk,sp}$	[kN]	3)	2,5	5,5	5,5	8,0	11,0	7,0	15,0	20,0
	Characteristic edge distance	$C_{cr,sp}$	[mm]	3)	58	84	64	82	98	80	114	130
	Characteristic spacing	$S_{cr,sp}$	[mm]	3)	116	168	128	164	196	160	224	260
<b>Concrete cone failure</b>												
Effective anchorage depth	$h_{ef}$	[mm]	25	34	42	32	41	49	40	57	65	
Factor	cracked	$k_{cr,N}$	[-]	7,7								
	uncracked	$k_{ucr,N}$	[-]	11,0								
Characteristic edge distance	$C_{cr,N}$	[mm]	$1,5 \cdot h_{ef}$									
Characteristic spacing	$S_{cr,N}$	[mm]	$3 \cdot h_{ef}$									

<sup>1)</sup> Only for statically indeterminate non-structural systems (multiple use) according to EN 1992-4:2018, in dry internal conditions.

<sup>2)</sup> In absence of other national regulations.

<sup>3)</sup> No performance assessed.

**Concrete Screw BSZ2**

**Performances**  
Characteristic values for **tension load**

**Annex C1**

**Table C2: Characteristic values for shear load under static or quasi static action**

Screw size			BSZ2 6			BSZ2 8			BSZ2 10			
Nominal embedment depth	$h_{nom}$	[mm]	35 <sup>1)</sup>	45	55	45	55	65	55	75	85	
Installation factor	$\gamma_{inst}$	[-]	1,0									
<b>Steel failure <u>without</u> lever arm</b>												
Characteristic resistance	$V^0_{Rk,s}$	[kN]	7,0			13,5		17,0		22,5		34,0
Partial factor <sup>2)</sup>	$\gamma_{Ms,V}$	[-]	1,25									
Ductility factor	$k_7$	[-]	0,8									
<b>Steel failure <u>with</u> lever arm</b>												
Characteristic bending resistance	$M^0_{Rk,s}$	[Nm]	10,9			26,0			56,0			
<b>Concrete pry-out failure</b>												
Pry-out factor	$k_8$	[-]	1,0	1,6		2,1		2,8		2,5		
<b>Concrete edge failure</b>												
Effective length of fastener in shear loading	$l_f = h_{nom}$	[mm]	35	45	55	45	55	65	55	75	85	
Outside diameter of anchor	$d_{nom}$	[mm]	6			8			10			

<sup>1)</sup> Only for statically indeterminate non-structural systems (multiple use) according to EN 1992-4:2018, in dry internal conditions.

<sup>2)</sup> In absence of other national regulations

**Concrete Screw BSZ2**

**Performances**  
Characteristic values for **shear load**

**Annex C2**

**Table C3: Characteristic values for seismic loading, performance category C1**

Screw size			BSZ2 6		BSZ2 8		BSZ2 10		
Nominal embedment depth	$h_{nom}$	[mm]	45	55	45	65	55	85	
Installation factor	$\gamma_{inst}$	[-]	1,0						
<b>Tension load (all types)</b>									
<b>Steel failure</b>									
Characteristic resistance	$N_{Rk,s,C1}$	[kN]	14,0		27,0		45,0		
Partial factor <sup>1)</sup>	$\gamma_{Ms,N}$	[-]	1,5						
<b>Pull-out failure</b>									
Characteristic resistance	$N_{Rk,p,C1}$	[kN]	1,5	3,0	3,0	8,5	6,0	17,0	
<b>Concrete cone failure</b>									
Effective anchorage depth	$h_{ef}$	[mm]	34	42	32	49	40	65	
Edge distance	$c_{cr,N}$	[mm]	$1,5 \cdot h_{ef}$						
Spacing	$s_{cr,N}$	[mm]	$3 \cdot h_{ef}$						
<b>Shear load (Type : B, S, SK, LK)</b>									
<b>Steel failure without lever arm</b>									
Characteristic resistance	Type B, S, LK	$V_{Rk,s,C1}$	[kN]	3,5	4,0	8,0	10,0	14,0	16,0
	Type SK	$V_{Rk,s,C1}$	[kN]	2,5	<sup>2)</sup>	4,5	7,0	14,0	10,0
Partial factor <sup>1)</sup>	$\gamma_{Ms,V}$	[-]	1,25						
<b>with</b> filling of annular gap	$\alpha_{gap}$	[-]	1,0						
<b>without</b> filling of annular gap	$\alpha_{gap}$	[-]	0,5						
<b>Concrete pry-out failure</b>									
Pry-out factor	$k_8$	[-]	1,6		2,1		2,8		2,5
<b>Concrete edge failure</b>									
Effective length of anchor	$l_f = h_{nom}$	[mm]	45	55	45	65	55	85	
Outside diameter of anchor	$d_{nom}$	[mm]	6		8		10		

<sup>1)</sup> In absence of other national regulations

<sup>2)</sup> No performance assessed

**Concrete Screw BSZ2**

**Performances**  
Characteristic values for seismic loading

**Annex C3**

**Table C4: Characteristic values under fire exposure**

Screw size			BSZ2 6			BSZ2 8			BSZ2 10			
Nominal anchorage depth	$h_{nom}$	[mm]	35 <sup>1)</sup>	45	55	45	55	65	55	75	85	
<b>Steel failure (tension and shear resistance)</b>												
Characteristic resistance	R30	$N_{Rk,s,fi}$ = $V_{Rk,s,fi}$	[kN]	0,9			2,4			4,4		
	R60			0,8			1,7			3,3		
	R90			0,6			1,1			2,3		
	R120			0,4			0,7			1,7		
<b>Steel failure <u>with</u> lever arm</b>												
Characteristic bending resistance	R30	$M^0_{Rk,s,fi}$	[Nm]	0,7			2,4			5,9		
	R60			0,6			1,8			4,5		
	R90			0,5			1,2			3,0		
	R120			0,3			0,9			2,3		
<b>Pull-out failure</b>												
Characteristic resistance	R30-R90	$N_{Rk,p,fi}$	[kN]	0,6	0,4	0,8	0,8	1,4	2,0	1,5	3,3	4,3
	R120	$N_{Rk,p,fi}$	[kN]	0,5	0,3	0,6	0,6	1,1	1,6	1,2	2,6	3,4
<b>Concrete cone failure</b>												
Characteristic resistance	R30-R90	$N^0_{Rk,c,fi}$	[kN]	0,5	1,2	2,0	1,0	1,9	2,9	1,7	4,2	5,9
	R120	$N^0_{Rk,c,fi}$	[kN]	0,4	0,9	1,6	0,8	1,5	2,3	1,4	3,4	4,7
Edge distance	$c_{cr,fi}$	[mm]	$2 \cdot h_{ef}$									
In case of fire attack from more than one side, the minimum edge distance shall be $\geq 300$ mm												
Spacing	$s_{cr,fi}$	[mm]	$4 \cdot h_{ef}$									
<b>Concrete pry-out failure</b>												
Pry-out factor	$k_8$	[-]	1,0	1,6	2,1	2,8	2,5					
The anchorage depth has to be increased for wet concrete by at least 30 mm compared to the given values.												

<sup>1)</sup> Only for statically indeterminate non-structural systems (multiple use) according to EN 1992-4:2018, in dry internal conditions.

**Concrete Screw BSZ2**

**Performances**  
Characteristic values under **fire exposure**

**Annex C4**



**Table C5: Displacements under static or quasi-static loads**

Screw size			BSZ2 6		BSZ2 8			BSZ2 10			
Nominal embedment depth	$h_{nom}$	[mm]	45	55	45	55	65	55	75	85	
<b>Tension load</b>											
cracked concrete	Tension load	N	[kN]	0,72	1,45	1,63	2,74	4,06	3,04	6,22	8,46
	Displacement	$\delta_{N0}$	[mm]	0,19	0,27	0,27	0,53	0,45	0,26	0,58	0,61
		$\delta_{N\infty}$	[mm]	0,55	0,84	0,49	0,66	0,61	0,69	0,92	1,10
uncracked concrete	Tension load	N	[kN]	2,11	4,07	4,24	5,97	8,03	5,42	9,17	12,28
	Displacement	$\delta_{N0}$	[mm]	0,42	0,43	0,33	0,49	0,58	0,84	0,62	0,79
		$\delta_{N\infty}$	[mm]	0,42	0,43	0,58			0,79		
<b>Shear load</b>											
Shear load	V	[kN]	3,3		8,6			16,2			
Displacement	$\delta_{V0}$	[mm]	1,55		2,7			2,7			
	$\delta_{V\infty}$	[mm]	3,1		4,1			4,3			

**Concrete Screw BSZ2**

**Performances**  
Displacements

**Annex C5**